

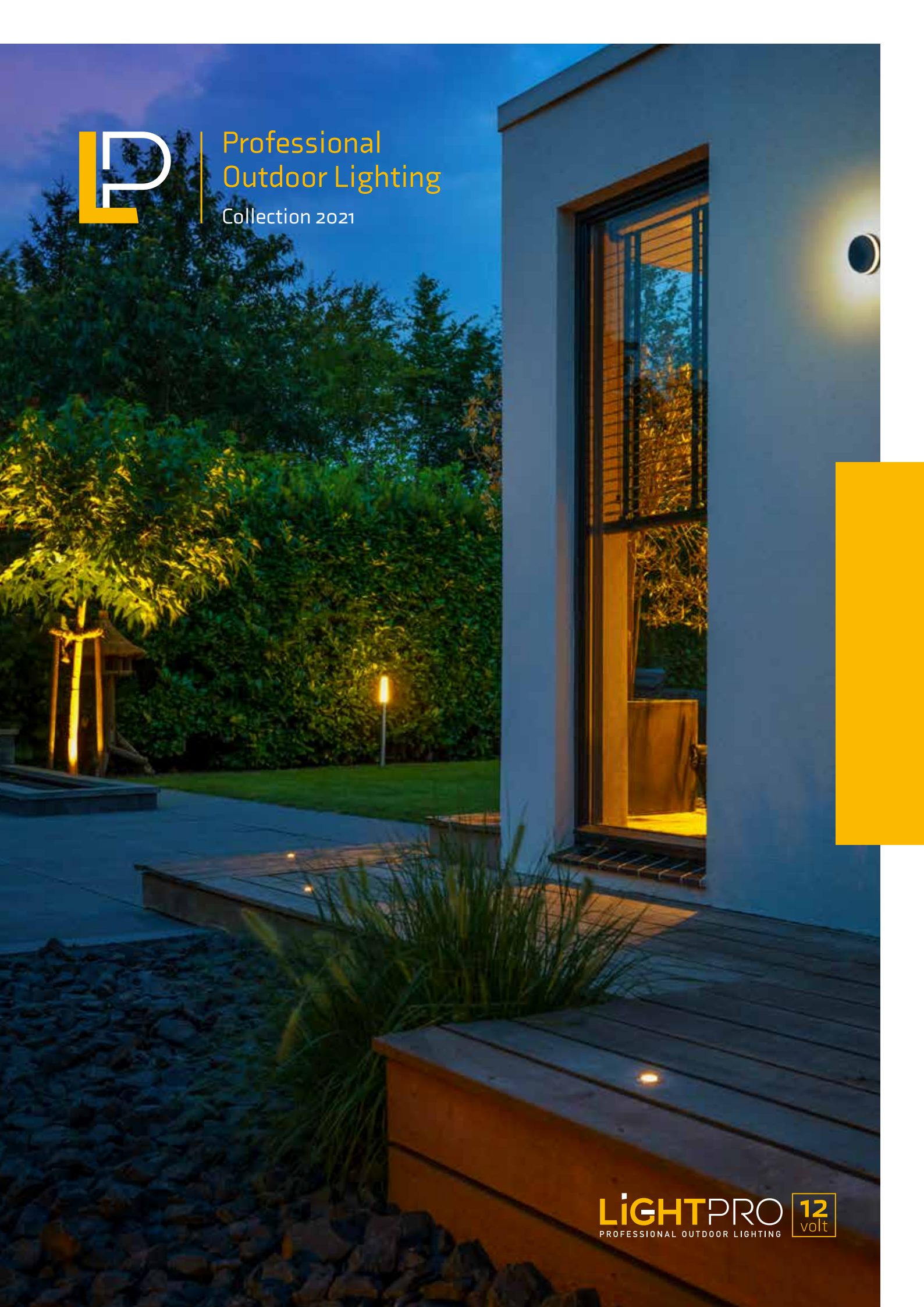

# Professional Outdoor Lighting

Collection 2021





# Professional outdoor lighting

Lightpro is a Techmar brand that focuses entirely on 12-volt outdoor lighting. We are the specialist that the professional can always turn to with questions and wishes.

Garden lighting not only creates atmosphere in the garden, but also contributes to security. At Lightpro, we design outdoor lighting especially for the garden that you want to put in the spotlight.

Lightpro's lights and accessories are developed based on low voltage (12 volts). This makes it safe, energy efficient and easy to install. In this brochure, you will find each of our light fittings, accessories and options. Take a look at the inspiring possibilities and get straight to work.

Discover what garden lighting can do for you!

5  
YEARS  
WARRANTY



# Contents

<b>Post lights</b>		<b>6</b>	<b>LED Strip</b>		<b>40</b>
Oberon Lo	190P	9	LED Strip	175L	40
Oberon Hi	191P	9	LED Strip Connector	211L	40
Oberon DL	192P	9			
Barite 40	112P	11	<b>Accessories</b>		<b>42</b>
Barite 60	111P	11	24W	198A	45
Barite DL	139P	11	Connector M	138A	45
Opal	115P	13	60W	144A	45
Nina	129P	13	Connector Y	143A	45
Nodin	128P	13	100W	145A	45
			12 volt Cable	025C14	47
<b>Spotlights</b>		<b>16</b>	12 volt Cable	050C14	47
Avior	181S	19	12 volt Cable	100C14	47
Nova 3	117S	19	12 volt Cable	200C14	47
Nova 5	116S	19	Extension cable	162A	47
Castor 3	177S	20	12 volt Extension cable	146A	47
Castor 4	178S	20	12 volt Extension cable	147A	47
Castor 8	179S	20	Connector F	137A	48
Castor 9	180S	20	Connector M	138A	48
Anti-glare hood	189A	20	Connector Y	143A	48
Nilus	210S	20	Ground spike	1363011	48
Juno 2	193S	21	Motion Sensor	165A	50
Juno 4	194S	21	NXT Switch	195A	50
			Receiver	167A	51
			Remote		
<b>Wall lighting</b>		<b>24</b>	+ Receiver	166A	51
Polaris	185W	27			
Kuma	184W	27	<b>Technical Information</b>		<b>53</b>
Ixion	182W	29	Explanation of the Lightpro system		54
Quartz	196W	29	Explanation of Lightpro Smart		56
			Post lights		58
<b>Uplights</b>		<b>32</b>	Spotlights		61
Atik R1	186U	34	Wall lighting		66
Atik R2	187U	34	Up- & Decklights		68
Agate	102U	35			
Nomia	207U	35			
<b>Decklights</b>		<b>36</b>			
Onyx 30 R1	150D	39			
Onyx 60 R1	151D	39			
Onyx 60 R3	153D	39			
Onyx 60 R4	154D	39			
Onyx 90 R1	156D	39			



**LIGHTPRO**  
PROFESSIONAL OUTDOOR LIGHTING

*“We work with Lightpro because it allows us to positively surprise our clients with interesting effects in a good quality and price ratio”*

Wojciech Mitek Migród - Technology in Green Areas, PL

## The advantages of our 12-volt system

### Energy efficient & sustainable

All of Lightpro's light fittings are equipped with LED light sources. The advantage of LED is that it is extremely low in energy consumption. The low heat emission ensures a long service life.

### Easy & flexible

Our system runs on 12 volts, which means that it can be installed without an electrician. The convenience of our 12-volt system is that it is easy to install, adapt and expand.

*“Lightpro is very easy and flexible to install without an electrician.”*

Above & Beyond Gardens, UK



All Lightpro products are sold through selected dealers. Find a point of sale near you by scanning this QR code with your mobile camera.

## Safe

With the 12-volt system, you don't need to worry about children or animals coming into contact with the cabling. 12 volts is a low voltage and therefore harmless. The system is safe to install and the cables do not need to be buried.

## Dutch design

We have our own innovation centre, where we design our products in-house. As a team, we are closely involved in the entire process, from design to the final product. In this way, we guarantee the best quality and offer a high-quality range.

## 5 Year warranty

You want to be able to enjoy your garden lighting for a long time without worries, that's why we give you a 5-year warranty on all our products.



# Post lights

## Post lights for a range of looks

With our outdoor post lights, you can easily create the atmosphere you want. If you want to illuminate borders or other plants, choose a light fitting that provides all-round light. A path or driveway becomes visible with a light fitting that provides direct light. This gives you less scattering of light. If you want extra light in some seasons, go for a dimmable light fitting. In this brochure, you will recognise these by the 'dimmable' icon. With a dimmable light, you can choose from 6 light intensities and provide a suitable lighting plan for every season.









Oberon Hi

With the **Oberon Hi**, you decide how much light you want along the pathway. This post light is dimmable in six light intensities.



**Oberon Lo** [190P]  
 Aluminum - Anthracite  
 LED 4W  
 3.000K - 400lm  
 420 x 64 mm (HxØ)



**Oberon Hi** [191P]  
 Aluminum - Anthracite  
 LED 4W  
 3.000K - 400lm  
 660 x 64 mm (HxØ)



NEW



**Oberon DL** [192P]  
 Aluminum - Anthracite  
 LED 9W  
 3.000K - 750lm  
 600 x 92,4 x 108,6 mm (HxWxD)



- See page 58 for other technical specifications.
- A connector is supplied with each light.

### Different functions with Oberon

Within our Oberon line, you can choose between three different post lights. We have two post lights that give light all around. With the difference in height, you can create depth in your garden. This gives a beautiful effect if you use them to illuminate different plants. A path or driveway is illuminated with the direct light of the Oberon downlighter. More light in winter or less light in summer? The luminaires of the Oberon are dimmable. With 6 different light intensity levels, you can decide what suits you best.

A tall, dark, cylindrical outdoor light fixture is shown against a background of dense green foliage. The fixture has a glowing top section, likely a light source, and a dark, possibly black, cap. The light is warm and yellowish. The background is a blurred wall of green leaves. The overall scene is outdoors at dusk or night.

Barite DL

The **Barite DL** is ideal for along pathways. You can clearly see where you are walking as the light beam is directed downwards. This also ensures that not too much light is diffused into the surroundings.



**Barite 40** [112P]  
 Aluminum - Black  
 LED 3W  
 3.000K - 190lm  
 495 x 65 mm (HxØ)



**Barite 60** [111P]  
 Aluminum - Black  
 LED 3W  
 3.000K - 190lm  
 575 x 65 mm (HxØ)



**Barite DL** [139P]  
 Aluminum - Black  
 LED 3W  
 3.000K - 130lm  
 495 x 65 x 145 mm (HxWxD)

- See page 59 for other technical specifications.
- A connector is supplied with each light.

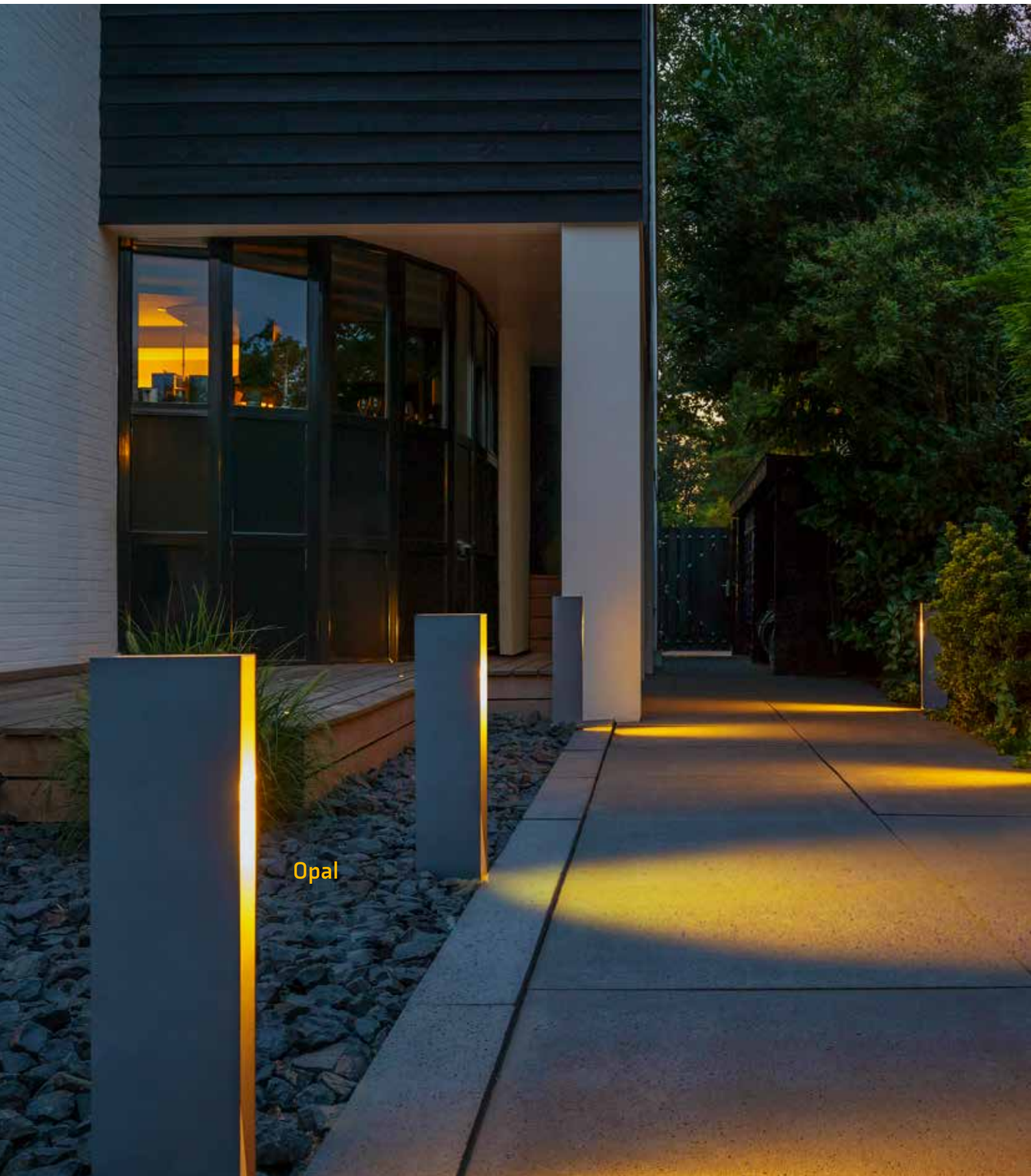

Opal

The **Opal** is a real eye-catcher with its unique design.



**Opal** [115P]  
Aluminum - Gray  
LED 3W  
3.000K - 190lm  
705 x 65 x 165 mm (HxWxD)



**Nina** [129P]  
Stainless steel 316  
LED 3W  
3.000K - 190lm  
757 x 105 mm (HxØ)



**Nodin** [128P]  
Stainless steel 316  
LED 3W  
3.000K - 190lm  
1018 x 105 mm (HxØ)

- See page 60 for other technical specifications.
- A connector is supplied with each light.

### Stainless steel post lights add an extra dimension to your garden

Stainless steel lights reflect the colours of the surroundings. They fit seamlessly into any design while also adding a special accent to your garden. The Nina and Nodin give a warm ambient light and the Opal has a downward directed light beam.



Oberon Hi



Oberon Lo



Barite DL





Nina

# Spotlights

## Spotlights give a surprising effect in the evening

With our spotlights, you can illuminate shrubs, trees or other objects in a tasteful way. We have spotlights with a range of different light beams. Illuminate a large tree with our very powerful spotlights. If you want to play with the light intensity, choose dimmable spotlights.





Castor 4

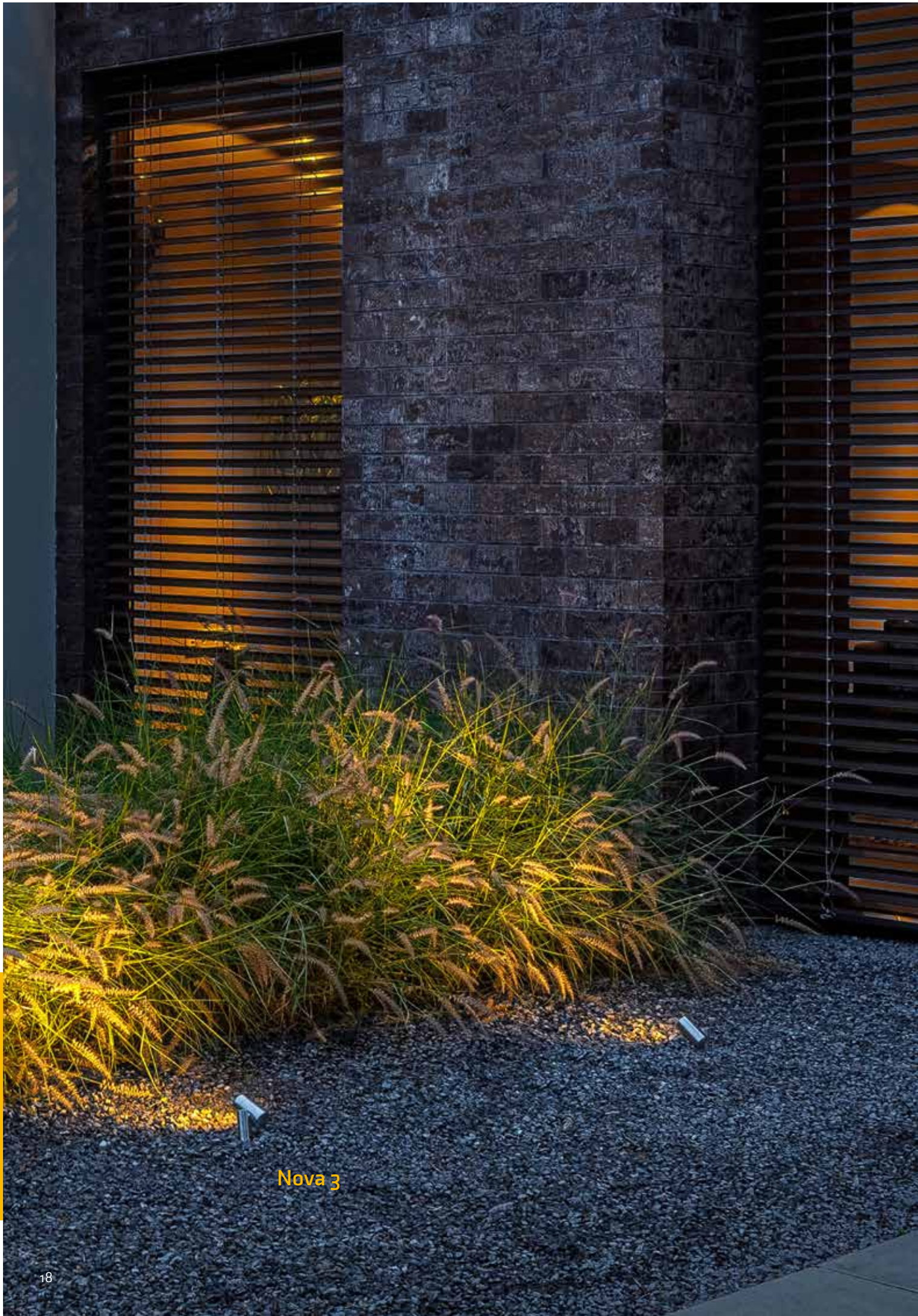

Nova 3



**Avior** [181S]  
 Aluminum - Anthracite  
 LED 16W  
 3.000K - 1500lm  
 125 x 180 x 68 mm (HxWxD)



**Nova 3** [117S]  
 Stainless steel 316  
 LED 3W  
 3.000K - 190lm  
 115 x 77 x 81 mm (HxWxD)



**Nova 5** [116S]  
 Stainless steel 316  
 LED 5W  
 3.000K - 320lm  
 180 x 100 x 120 mm (HxWxD)

- See page 61 for other technical specifications.
- A connector is supplied with each light.

**Spotlights are used to illuminate trees, shrubs, statues and houses.**

Spotlights allow you to set the right angle to illuminate a beautiful tree. Not every spotlight can be used for the same purpose, which is why we offer different variants. You will always find the perfect spotlight for your garden. Take a look at our dimmable spotlights. With these, you can coordinate the light to the growth of the trees or shrubs and to the different seasons of the year!



**Castor 3** [177S]  
 Aluminum - Anthracite  
 LED 2,5W  
 3.000K - 200lm  
 95 x 60 x 100 mm (HxWxD)



**Castor 4** [178S]  
 Aluminum - Anthracite  
 LED 3,5W  
 3.000K - 400lm  
 95 x 60 x 100 (HxWxD)



**Castor 8** [179S]  
 Aluminum - Anthracite  
 LED 8W  
 3.000K - 800lm  
 95 x 60 x 120 mm (HxWxD)



**Castor 9** [180S]  
 Aluminum - Anthracite  
 LED 9W  
 3.000K - 750lm  
 95 x 60 x 120 mm (HxWxD)



exchangeable reflector



**Anti-glare hood** [189A]  
 for the Castor



**NEW**

**Underwater spotlight Nilus** [210S]  
 ABS - Black  
 LED 4W  
 3.000K - 400lm  
 129 x 95 x 109 mm (HxWxD)





**Castor** and **Juno** spotlights pair perfectly. We've coordinated the fittings so that you can place them next to each other in one garden. This allows you to alternate with different light intensities while maintaining a calm effect. Some Castor spots are dimmable so that you can easily adjust the light to suit the season or the growth of your plants.



**Juno 2** [193S]  
Aluminum - Anthracite  
LED 1,5W  
3.000K - 192lm  
85 x 55 x 68 mm (HxWxD)



**Juno 4** [194S]  
Aluminum - Anthracite  
LED 4W  
3.000K - 372lm  
85 x 55 x 68 mm (HxWxD)

- See page 62, 63 and 64 for other technical specifications.
- A connector is supplied with each light.



Castor



Castor



Nova



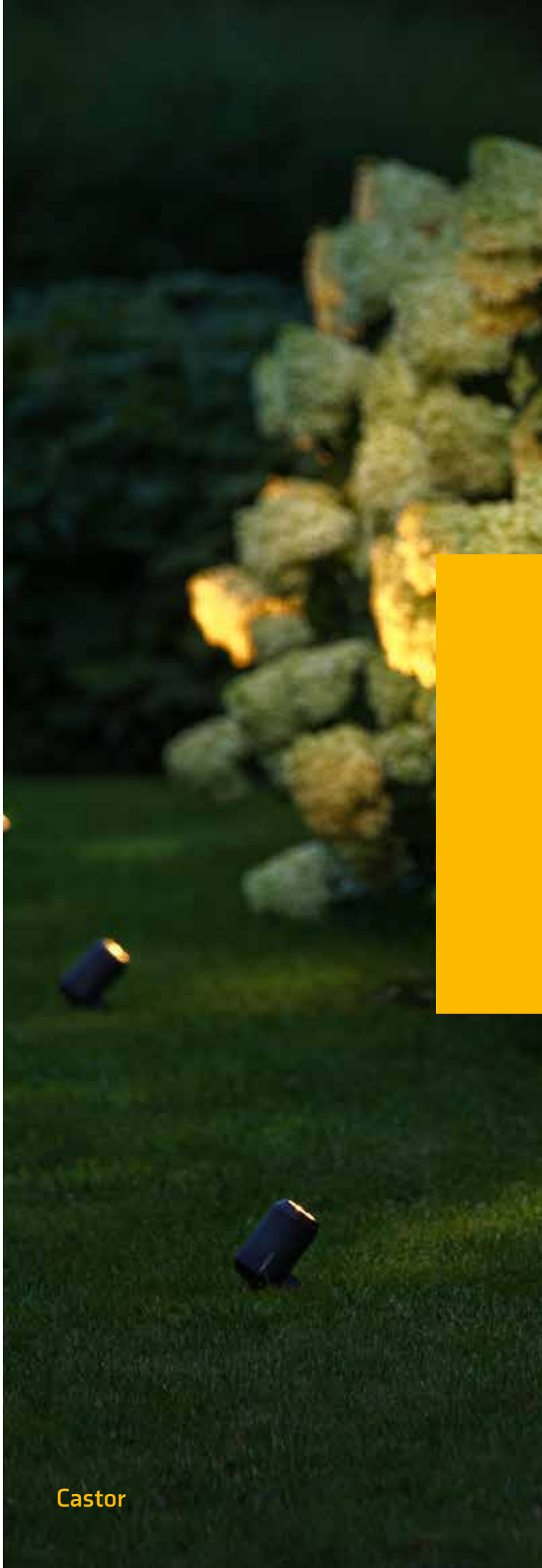

Castor

Wall lighting

## Wall lighting for garden and terrace

With our wall lights, you can light up your fence,  
garden wall or canopy in no time.







The application possibilities of wall lights are endless. With several wall lights on a fence you emphasize the depth of your garden.

With the Kuma close to the ground, the light becomes functional and you can choose to illuminate pathways. Gazebos and pergolas become even more beautiful with the right wall light. For freedom with the light angle, choose the Ixion. This makes it easy to adjust the angle of the light beam.



**Polaris** [185W]  
Aluminum - Anthracite  
LED 6W  
3.000K - 500lm  
145 x 35 mm (DxT)



**Kuma** [184W]  
Aluminum - Anthracite  
LED 6W  
3.000K - 300lm  
145 x 35 mm (DxT)

- See page 66 for other technical specifications.
- A connector is supplied with each light.

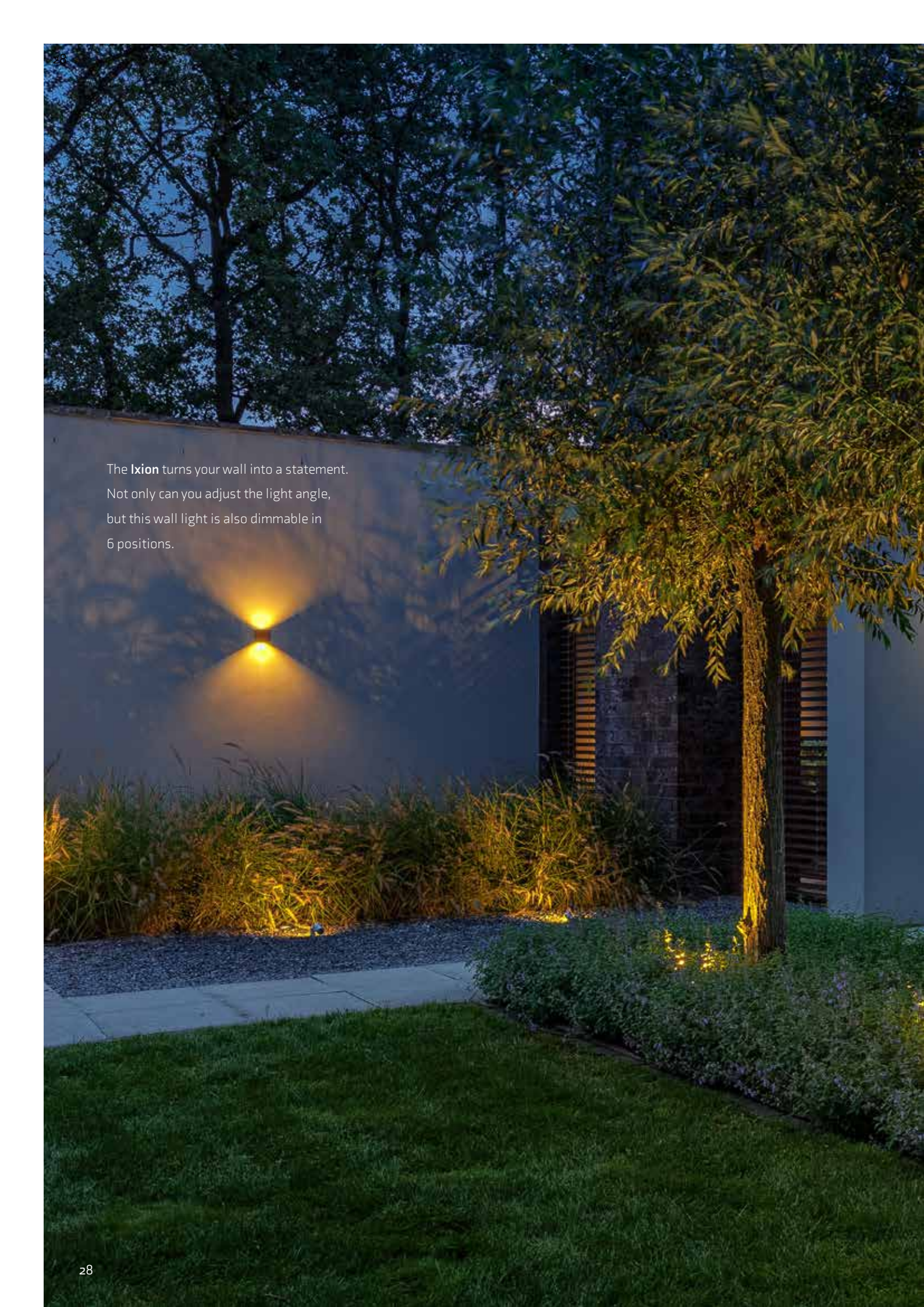

The **Ixion** turns your wall into a statement. Not only can you adjust the light angle, but this wall light is also dimmable in 6 positions.



**Ixion** [182W]  
Aluminum - Anthracite  
LED 9W  
3.000K - 534lm  
110 x 110 x 110 mm (HxWxD)



**Quartz** [196W]  
Aluminum - Black  
LED 2W  
3.000K - 120lm  
105 x 50 x 85 mm (HxWxD)

- See page 67 for other technical specifications.
- A connector is supplied with each light.



Kuma



Polaris







Ixion

# Uplights

## Illuminate your garden with high quality uplights

Would you like to illuminate a tree, shrub or other object from below? That is possible with our uplights. In the evening they give a beautiful light effect. An umbrella tree that looks truly spectacular with the right lighting.





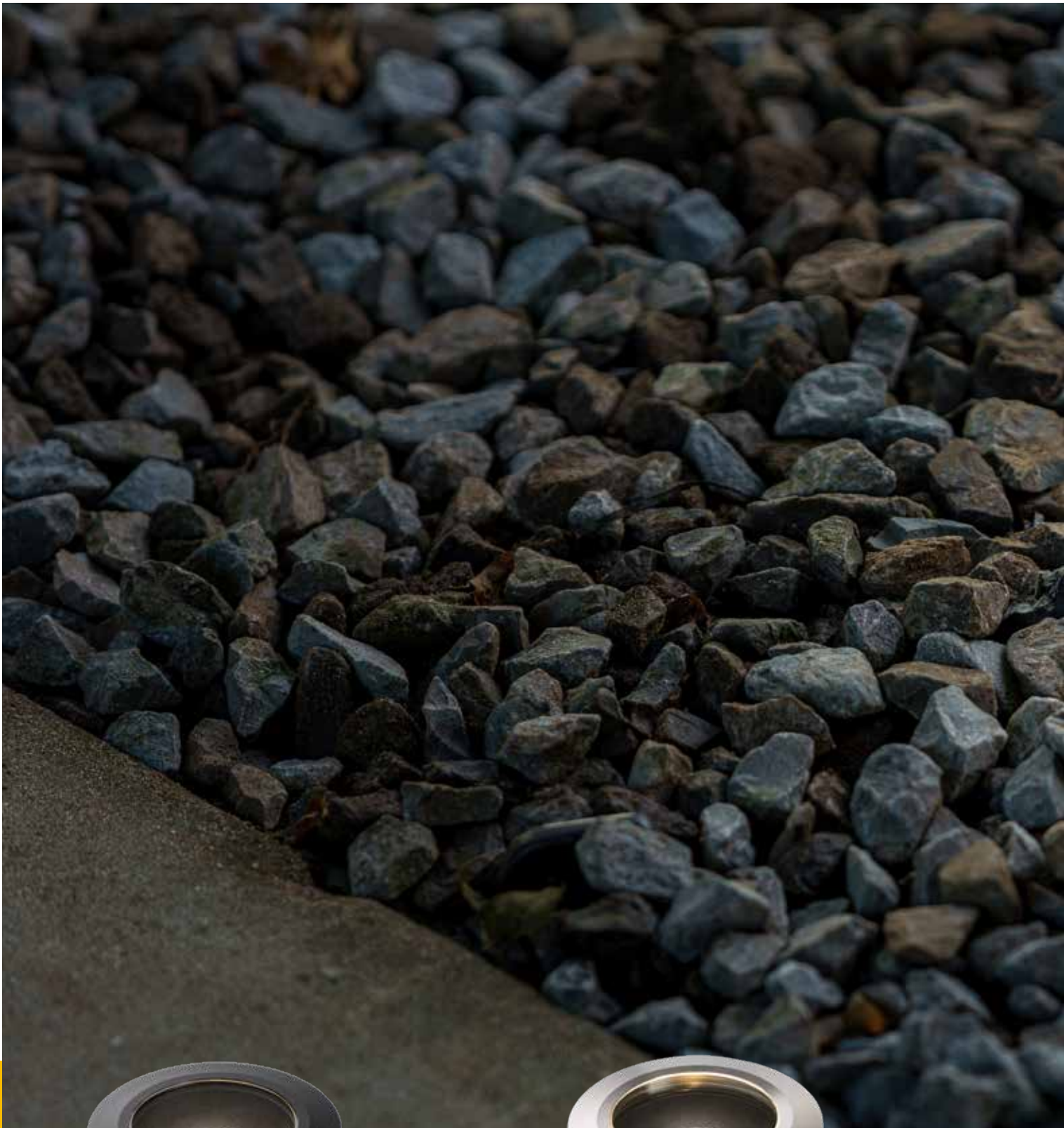

**Atik R1** [186U]  
Aluminum - Anthracite  
LED gW  
3.000K - 750lm  
115 x 120 mm (HxØ)  
Drillhole 100 mm



**Atik R2** [187U]  
Stainless steel 316  
LED gW  
3.000K - 750lm  
115 x 120 mm (HxØ)  
Drillhole 100 mm



Our uplights are in-ground spotlights that you can use for various purposes. You simply incorporate them into the gravel or sand to illuminate an object.

The nice thing about these spotlights is that you don't see them during the day, but at night they emphasize the height of the trees and the beautiful leaves.

The light range and light angle play a big role in the choice of the spotlight.



**Agate [102U]**  
Stainless steel 316  
LED 3W  
3.000K - 190lm  
113 x 113 mm (HxØ)  
Drillhole 90 mm



**NEW**

**Nomia [207U]**  
Aluminum - black  
LED 3W  
3.000K - 313lm  
86 x 90 mm (HxØ)  
Drillhole 70 mm

- See page 69 and 72 for other technical specifications.
- A connector is supplied with each light.

# Decklights

**For orientation  
lighting we  
recommend  
decklights.**

Decklights from Lightpro are modern, have an attractive appearance and are also very easy to install. Our wide range of high-quality lighting offers the best solution for every garden. If you want to go for the optimal result, choose multiple decklights. Apply, for example, a line of lights along the side of a pathway or place them randomly for a beautiful star path!



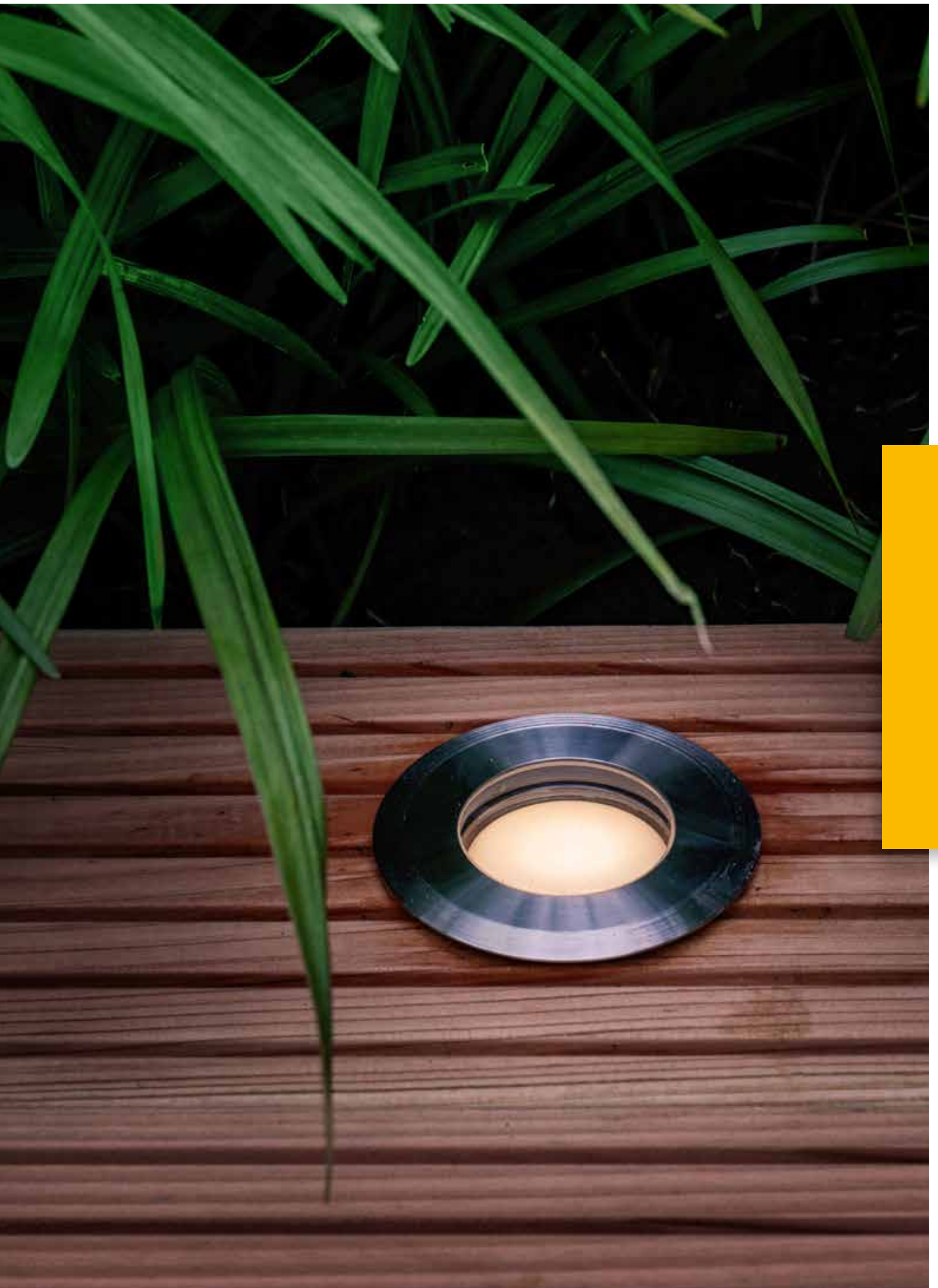

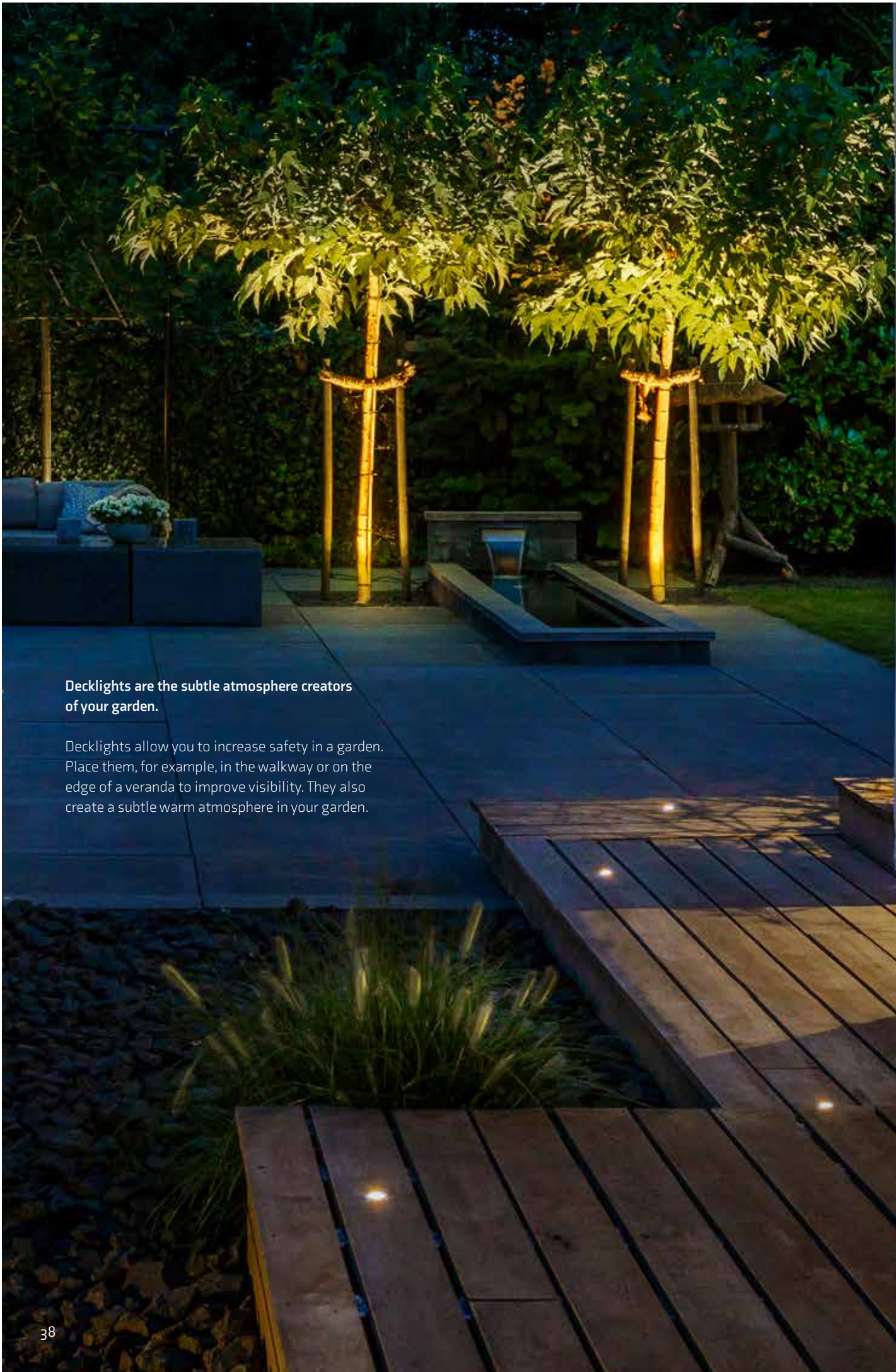

**Decklights are the subtle atmosphere creators of your garden.**

Decklights allow you to increase safety in a garden. Place them, for example, in the walkway or on the edge of a veranda to improve visibility. They also create a subtle warm atmosphere in your garden.





**Onyx 30 R1** [150D]  
 Stainless steel 316  
 LED 0,5W  
 2.700K- 4lm  
 41 x 45 mm (HxØ)  
 Drillhole: 30mm



**Onyx 60 R1** [151D]  
 Stainless steel 316  
 LED 1W  
 2.700K - 23lm  
 42 x 75 mm (HxØ)  
 Drillhole: 60mm



**Onyx 60 R3** [153D]  
 Stainless steel 316  
 LED 1W  
 2.700K - 23lm  
 42 x 75 mm (HxØ)  
 Drillhole: 60mm



**Onyx 60 R4** [154D]  
 Stainless steel 316  
 LED 1W  
 2.700K - 23lm  
 42 x 75 x 75 mm (HxWxD)  
 Drillhole: 60mm



**Onyx 90 R1** [156D]  
 Stainless steel 316  
 LED 1,5W  
 2.700K - 76lm  
 43 x 105 mm (HxØ)  
 Drillhole: 90mm

Lenses supplied  
 as standard:

Clear



Star



Opal



- See page 68 and 69 for other technical specifications.
- A connector is supplied with each light.

# LED Strip

Our multi-purpose LED Strip is made of flexible silicone and issues warm light. The LED Strip is perfect for use in a staircase, a border or in a pergola and thus easily increases the safety and atmosphere of the garden.

**LED Strip**[175L]  
Synthetic  
15m

**LED Strip Connector**[211L]  
Synthetic  
Incl. Connector F

*The LED Strip connector is available separately.*



The LED strip is 15 meters long and can be shortened as required.

• See page 71 for other technical specifications.

## Accessories

# Lightpro 12-volt exterior lighting? Not without accessories!

For the installation of 12-volt outdoor lighting, accessories such as transformers, cable, and connectors are required. A motion detector and remote control can also be a good addition to the lighting plan.









**The transformer is the beginning of your system.**

To choose the right transformer for your lighting plan, add up the wattages of all your lights. You then look at how much cable you need and which accessories you want to add. Keep in mind that the 60W and 100W transformer can be loaded up to 75%.



**24W [198A]**  
Transformer



**Connector M [138A]**  
Type M (Male)  
(for branch and 24W transformer)



**60W [EU: 144A / UK: 163A]**  
Transformer  
(Incl. light sensor and timer function)

**100W [EU: 145A / UK 164A]**  
Transformer  
(Incl. light sensor and timer function)



**Connector Y [143A]**  
Type Y  
(for 60 + 100W transformer)







**12 volt Cable** [025C14]  
14AWG  
25m



**12 volt Cable** [050C14]  
14AWG  
50m



**12 volt Cable** [100C14]  
14AWG  
100m



**12 volt Cable** [200C14]  
14AWG  
200m



**Extension cable** [162A]  
for Sensor  
6m



**12 volt Extension cable** [146A]  
SPT-2W - 1m

**12 volt Extension cable** [147A]  
SPT-2W - 3m

Each Lightpro connector is designed to simplify installation.

With the female connector you can connect any light or accessory to the main cable in no time. With the male connector you make a branch, and the connector Y ensures a safe connection of the transformer.



**Connector F [137A]**  
Type F (Female)



**Connector M [138A]**  
Type M (Male)  
(for branch and 24W transformer)



**Connector Y [143A]**  
Type Y  
(for 60 + 100W transformer)



**Ground spike [1363011]**  
Use for  
Nina, Nodin and Opal



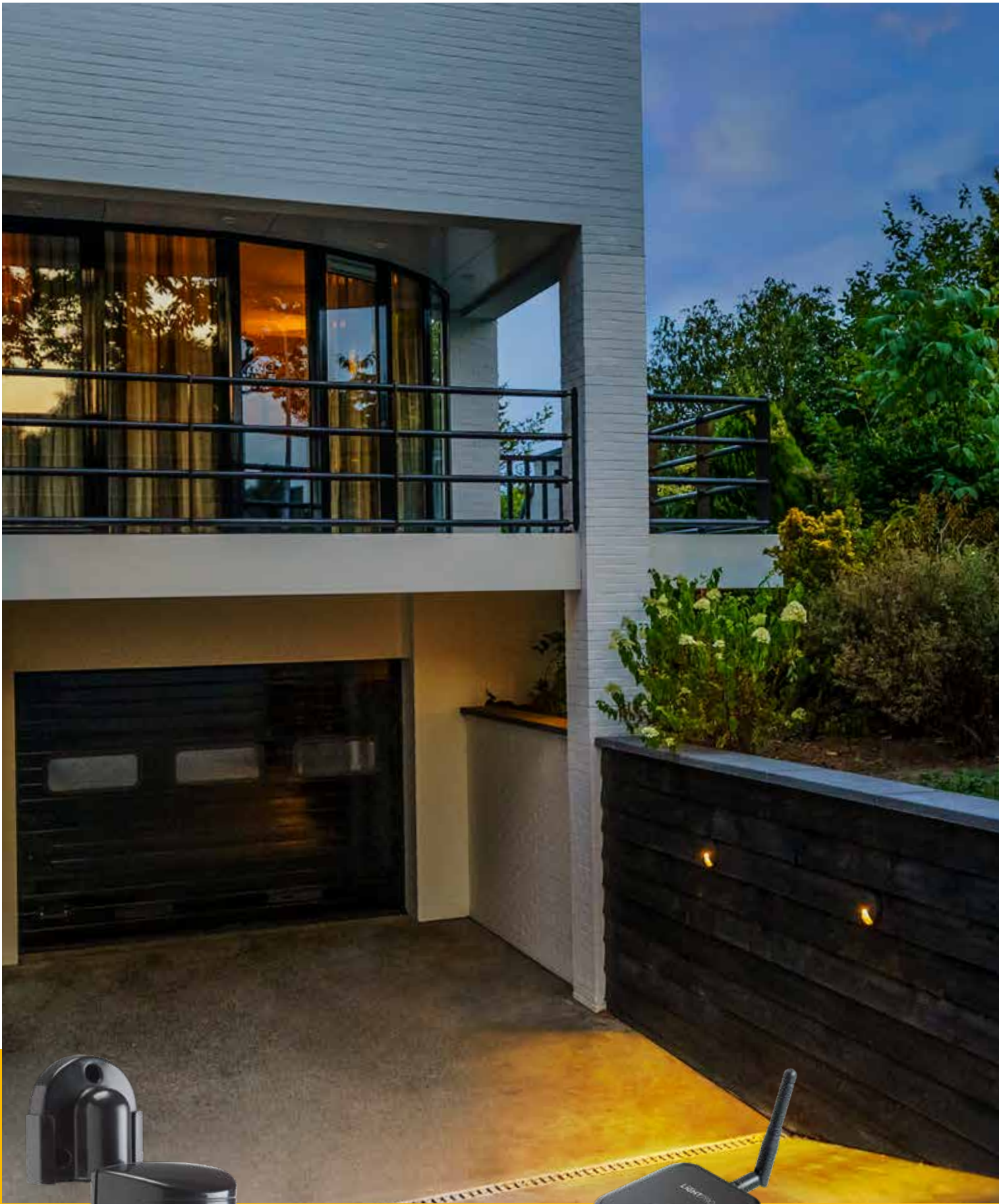

Motion Sensor [165A]



NXT Switch [195A]

**LIGHTPRO | NXT**  
PROFESSIONAL OUTDOOR LIGHTING

Accessories make life easy. You'll never walk to the shed in the dark again thanks to the motion sensor. Switch the outside lighting on and off with the remote control. Or go for total convenience with the NXT Switch. With the NXT Switch, you can create zones in your garden, save your favourite scenes and set as many timers as you like.



Receiver [167A]



Remote  
+ Receiver [166A]



# Technical information

Explanation of the Lightpro system	54
Explanation of Lightpro Smart	56
Post lights	58
Spotlights	61
Wall lighting	66
Up- & Decklights	68

# Explanation of the Lightpro system

We think it is important that you can install outdoor lighting quickly, easily and safely. We've made this possible with our 12-volt system!

## The advantages of our 12-volt system:

- Energy efficient and sustainable
- Easy and quick to connect
- Cable does not need to be buried
- Very safe for children and animals

All our products and accessories can be connected to the Lightpro 12-volt system. Depending on the number of lights and their distribution, you can install up to 80 metres. Need more? Simply create a branch directly at the transformer. Keep in mind that the transformer can be loaded up to 75%.

In just a few steps you can easily install our outdoor lighting.

### The lights and cable

1. Place the lights in the desired place and roll out the cable.
2. Insert the lights and connect the Connector F to the main cable.
3. Connect the cable of the light to the Connector F.

### The transformer

4. Insert the starting point of the main cable into the Connector Y and tighten.
5. Connect the Connector Y to the transformer.
6. Insert the transformer plug into the wall socket.

Do you need a more in-depth explanation? Take a look on our YouTube channel.

Just twist and connect! ●●●●

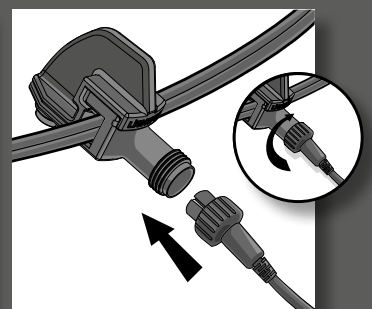
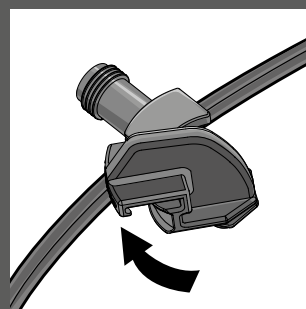
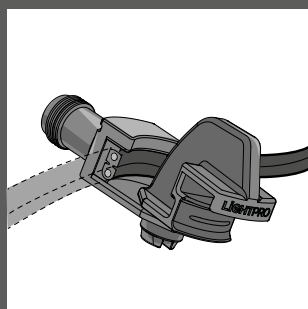
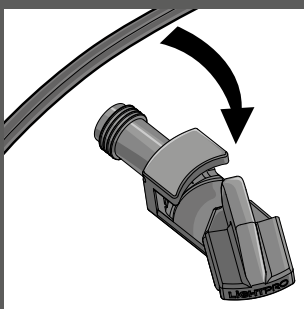



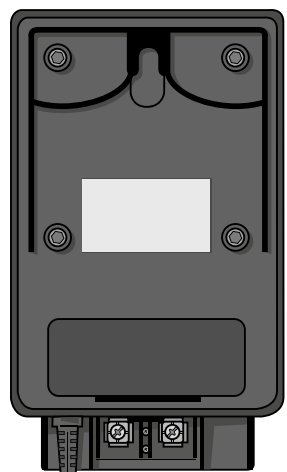

Transformer (144A/145A)

Connection to transformer

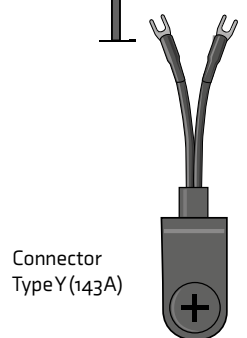

Connector Type Y (143A)

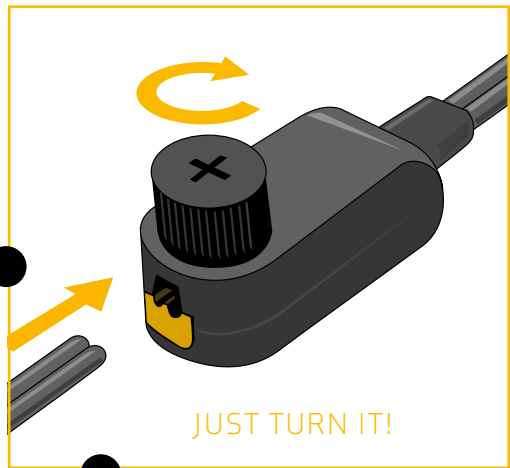

JUST TURN IT!

Connection to make a branch

Connector Type F (137A)

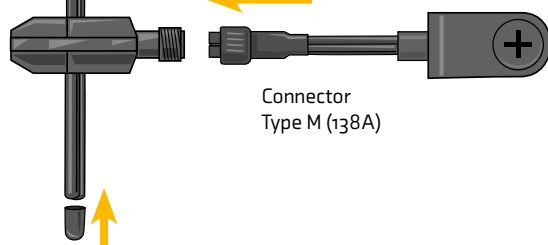

Connector Type M (138A)

# Explanation of Lightpro Smart

## Lightpro NXT

Lightpro NXT is the solution for creating a SMART garden with the Lightpro 12-volt lights. It works just as easy as the Lightpro system itself. All you need to do is add the Lightpro NXT Switch.

With the Lightpro app you can then easily create zones in the garden and switch them on and off separately. Or create a scene and set one or more timers.

### Connect the switch:

You can connect the Lightpro NXT Switch to the garden lighting in several different ways:

1. If you want to work with one zone, you can install the NXT Switch between the transformer and the main cable.
2. If you want to control one area with the app, install the NXT Switch on a branch.
3. If you want to create different zones, you will need to install one NXT Switch per branch.

Visit [www.lightpro.nl](http://www.lightpro.nl) for more information, Tips & Tricks.

**LIGHTPRO** | NXT  
PROFESSIONAL OUTDOOR LIGHTING

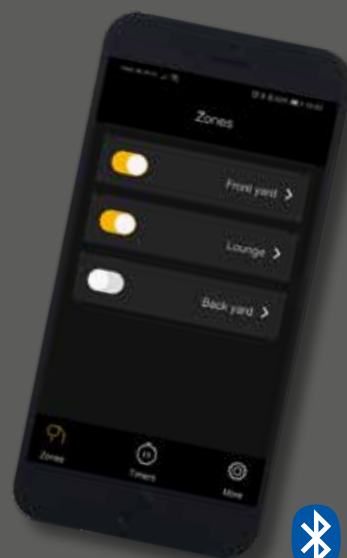

Just twist and connect! ●●●

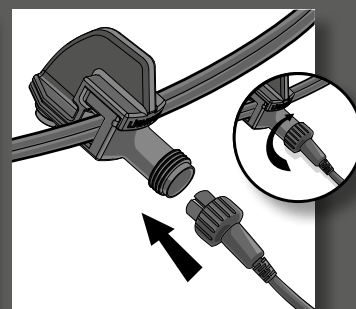
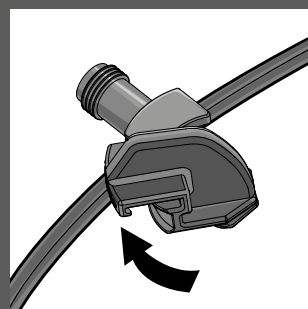
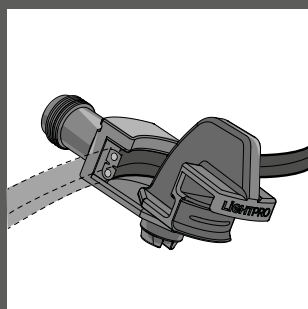
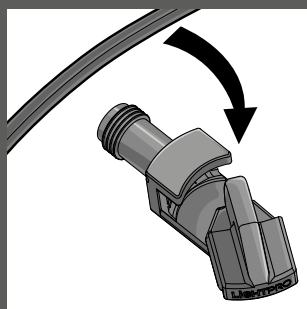

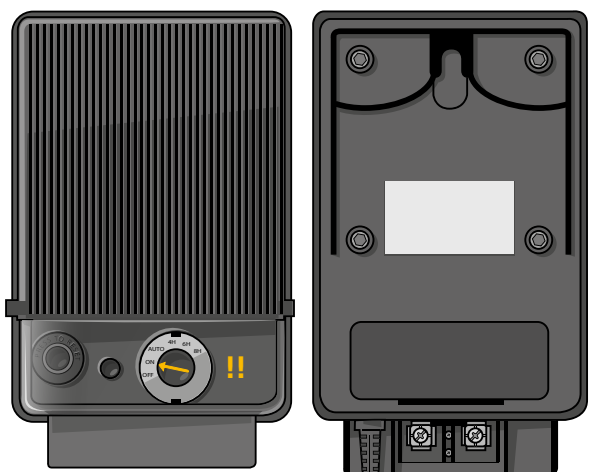

Transformer (144A/145A)

Connecting a luminaire or a specific group of luminaires to the switch.

Connection to the transformer

Connector Type Y (143A)

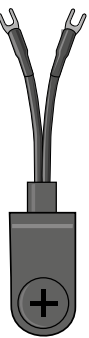

Switch (195A)

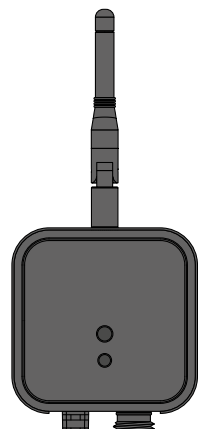

Connector Type F (137A)

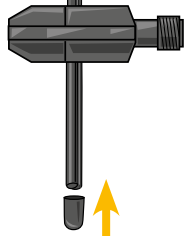

Connect a lamp

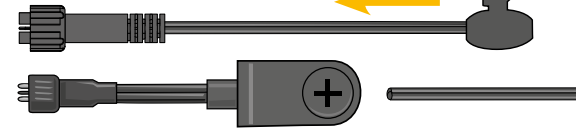

or make a turn

Connector Type M (138A)

# Post lights

## Oberon Lo

Article number 190P | EAN code 8719979280796 | HS Code 94054091 | Warranty 5 Years

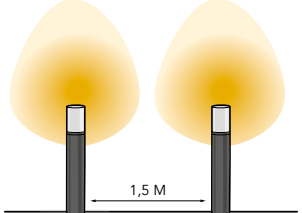
Product		Light source		Supplied accessories / contents
Material	Aluminum	Type	SMD	Mounting material
Colour	Anthracite	Replaceable	No	Connector F
Cable	1 m. Ho5RN-F	Voltage	12 V AC/DC	Ground spike
		Start-up voltage	9 V	Hex key
Diameter	64 mm	Wattage	4 W	
Height	420 mm	Lumen output	40 - 400 lm	
Drillhole	-	Light colour (CCT)	3.000 K	<b>Light beam / -effect</b>
IP Class	IP44	Light angle	-	
Protection class	III	Average lifetime	20.000 hours	
		CRI	82	
		Switch on/off	10.000	
		Dimmable	Yes	
		Energy class	A+	

## Oberon Hi

Article number 191P | EAN code 8719979280802 | HS Code 94054091 | Warranty 5 Years

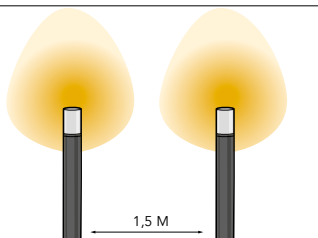
Product		Light source		Supplied accessories / contents
Material	Aluminum	Type	SMD	Mounting material
Colour	Anthracite	Replaceable	No	Connector F
Cable	1 m. Ho5RN-F	Voltage	12 V AC/DC	Ground spike
		Start-up voltage	9 V	Hex key
Diameter	64 mm	Wattage	4 W	
Height	660 mm	Lumen output	40 - 400 lm	
Drillhole	-	Light colour (CCT)	3.000 K	<b>Light beam / -effect</b>
IP Class	IP44	Light angle	-	
Protection class	III	Average lifetime	20.000 hours	
		CRI	82	
		Switch on/off	10.000	
		Dimmable	Yes	
		Energy class	A+	

## Oberon DL

Article number 192P | EAN code 8719979282080 | HS Code 94054091 | Warranty 5 Years

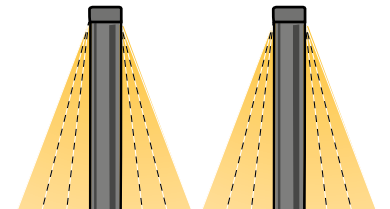
Product		Light source		Supplied accessories / contents
Material	Aluminum	Type	COB	Mounting material
Colour	Anthracite	Replaceable	No	Connector F
Cable	1 m. Ho5RN-F	Voltage	12 V AC/DC	Ground spike
		Start-up voltage	9 V	Hex key
Length	108,6 mm	Wattage	9 W	Interchangeable plates
Diameter	92,4 mm	Lumen output	750 lm	
Height	600 mm	Light colour (CCT)	3.000 K	<b>Light beam / -effect</b>
Drillhole	-	Light angle	Variabel	
IP Class	IP44	Average lifetime	20.000 hours	
Protection class	III	CRI	91	
		Switch on/off	10.000	
		Dimmable	Yes	
		Energy class	A+	

## Barite 40

Article number 112P | EAN code 5907800856873 | HS Code 94054091 | Warranty 5 Years

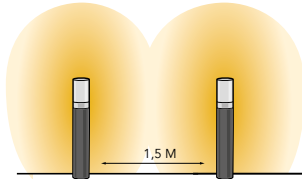
Product		Light source		Supplied accessories / contents
Material	Aluminum	Type	MR16	Mounting material
Colour	Black	Replaceable	Yes	Connector F
Cable	1 m. H05RN-F	Voltage	12 V AC/DC	Foam ring
		Start-up voltage	9 V	Ground spike
Diameter	65 mm	Wattage	3 W	Hex key
Height	405 mm	Lumen output	190 lm	
Drillhole	-	Light colour (CCT)	3.000 K	<b>Light beam / -effect</b>
IP Class	IP44	Light angle	-	
Protection class	III	Average lifetime	20.000 hours	
		CRI	84	
		Switch on/off	10.000	
		Dimmable	No	
		Energy class	A+	

## Barite 60

Article number 111P | EAN code 5907800856866 | HS Code 94054091 | Warranty 5 Years

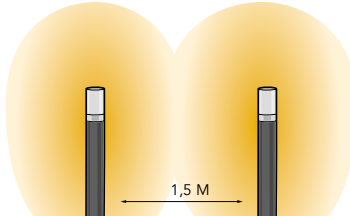
Product		Light source		Supplied accessories / contents
Material	Aluminum	Type	MR16	Mounting material
Colour	Black	Replaceable	Yes	Connector F
Cable	1 m. H05RN-F	Voltage	12 V AC/DC	Foam ring
		Start-up voltage	9 V	Ground spike
Diameter	65 mm	Wattage	3 W	Hex key
Height	575 mm	Lumen output	190 lm	
Drillhole	-	Light colour (CCT)	3.000 K	<b>Light beam / -effect</b>
IP Class	IP44	Light angle	-	
Protection class	III	Average lifetime	20.000 hours	
		CRI	84	
		Switch on/off	10.000	
		Dimmable	No	
		Energy class	A+	

## Barite DL

Article number 139P | EAN code 5907800857535 | HS Code 94054091 | Warranty 5 Years

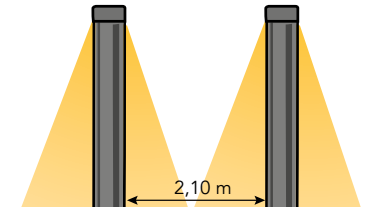
Product		Light source		Supplied accessories / contents
Material	Aluminum	Type	SMD	Mounting material
Colour	Black	Replaceable	Yes	Connector F
Cable	1 m. H05RN-F	Voltage	12 V AC/DC	Foam ring
		Start-up voltage	9 V	Ground spike
Length	145 mm	Wattage	3 W	Hex key
Width	65 mm	Lumen output	130 lm	
Height	495 mm	Light colour (CCT)	3.000 K	<b>Light beam / -effect</b>
Drillhole	-	Light angle	-	
IP Class	IP44	Average lifetime	20.000 hours	
		CRI	76	
		Switch on/off	10.000	
		Dimmable	No	
		Energy class	A	

## Opal

Article number 115P | EAN code 5907800856903 | HS Code 94054091 | Warranty 5 Years

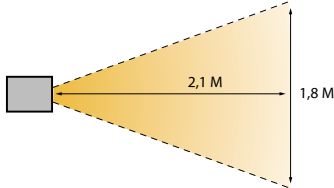
Product		Light source		Supplied accessories / contents
Material	Aluminum	Type	MR16	Mounting material
Colour	Gray	Replaceable	Yes	Connector F
Cable	1 m. Ho5RN-F	Voltage	12 V AC/DC	
Length	165 mm	Start-up voltage	9 V	Ground spike (Sold separately. See page 48)
Width	65 mm	Wattage	3 W	
Height	705 mm	Lumen output	190 lm	
Drillhole	-	Light colour (CCT)	3.000 K	
IP Class	IP44	Light angle	40°	
Protection class	III	Average lifetime	20.000 hours	
		CRI	84	
		Switch on/off	10.000	
		Dimmable	No	
		Energy class	A+	

## Nina

Article number 129P | EAN code 5907800857047 | HS Code 94054091 | Warranty 5 Years

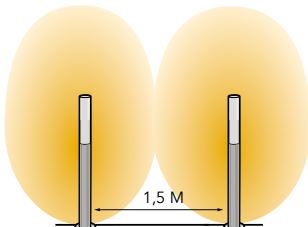
Product		Light source		Supplied accessories / contents
Material	Stainless steel 316	Type	MR16	Mounting material
Colour	Gray	Replaceable	Yes	Connector F
Cable	1 m. Ho5RN-F	Voltage	12 V AC/DC	
		Start-up voltage	9 V	Ground spike (Sold separately. See page 48)
Durchmesser	105 mm	Wattage	3 W	
Height	757 mm	Lumen output	190 lm	
Drillhole	-	Light colour (CCT)	3.000 K	
IP Class	IP44	Light angle	-	
Protection class	III	Average lifetime	20.000 hours	
		CRI	84	
		Switch on/off	10.000	
		Dimmable	No	
		Energy class	A+	

## Nodin

Article number 128P | EAN code 5907800857030 | HS Code 94054091 | Warranty 5 Years

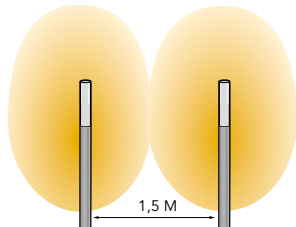
Product		Light source		Supplied accessories / contents
Material	Stainless steel 316	Type	MR16	Mounting material
Colour	Gray	Replaceable	Yes	Connector F
Cable	1 m. Ho5RN-F	Voltage	12 V AC/DC	
		Start-up voltage	9 V	Ground spike (Sold separately. See page 48)
Diameter	105 mm	Wattage	3 W	
Height	1018 mm	Lumen output	190 lm	
Drillhole	-	Light colour (CCT)	3.000 K	
IP Class	IP44	Light angle	-	
Protection class	III	Average lifetime	20.000 hours	
		CRI	84	
		Switch on/off	10.000	
		Dimmable	No	
		Energy class	A+	

# Spotlights

## Avior

Article number 1815 | EAN code 5907800859928 | HS Code 94054091 | Warranty 5 Years

Product		Light source		Supplied accessories / contents
Material	Aluminum	Type	COB	Mounting material
Colour	Anthracite	Replaceable	No	Connector F
Cable	1 m. Ho5RN-F	Voltage	12 V AC/DC	Ground spike
Length	68 mm	Start-up voltage	9 V	Hex key
Width	180 mm	Wattage	16 W	
Height	125 mm	Lumen output	150 - 1500 lm	
Drillhole	-	Light colour (CCT)	3.000 K	Light beam / -effect
IP Class	IP44	Light angle	100°	
Protection class	III	Average lifetime	20.000 hours	
		CRI	80	
		Switch on/off	10.000	
		Dimmable	Yes	
		Energy class	A+	

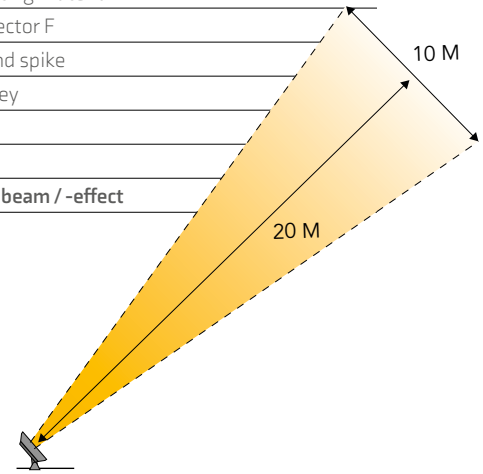

## Nova 3

Article number 1175 | EAN code 5907800856927 | HS Code 94054091 | Warranty 5 Years

Product		Light source		Supplied accessories / contents
Material	Stainless steel 316	Type	MR11	Mounting material
Colour	Gray	Replaceable	Yes	Connector F
Cable	1 m. Ho5RN-F	Voltage	12 V AC/DC	Ground spike
Length	81 mm	Start-up voltage	9 V	
Width	77 mm	Wattage	3 W	
Height	115 mm	Lumen output	190 lm	
Drillhole	-	Light colour (CCT)	3.000 K	Light beam / -effect
IP Class	IP44	Light angle	30°	
Protection class	III	Average lifetime	20.000 hours	
		CRI	84	
		Switch on/off	10.000	
		Dimmable	No	
		Energy class	A+	

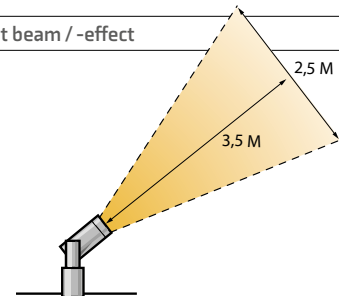

## Nova 5

Article number 1165 | EAN code 5907800856910 | HS Code 94054091 | Warranty 5 Years

Product		Light source		Supplied accessories / contents
Material	Stainless steel 316	Type	MR16	Mounting material
Colour	Gray	Replaceable	Yes	Connector F
Cable	1 m. Ho5RN-F	Voltage	12 V AC/DC	Ground spike
Length	120 mm	Start-up voltage	9 V	
Width	100 mm	Wattage	5 W	
Height	180 mm	Lumen output	320 lm	
Drillhole	-	Light colour (CCT)	3.000 K	Light beam / -effect
IP Class	IP44	Light angle	40°	
Protection class	III	Average lifetime	20.000 hours	
		CRI	80	
		Switch on/off	10.000	
		Dimmable	No	
		Energy class	A	

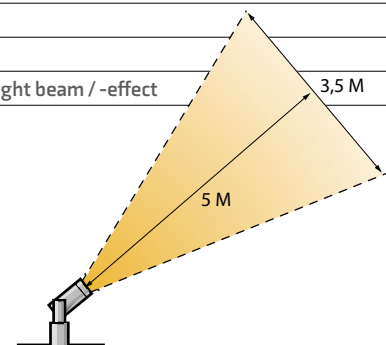

## Castor 3

Article number 1775 | EAN code 5907800859881 | HS Code 94054091 | Warranty 5 Years

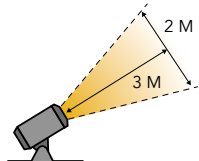
Product		Light source		Supplied accessories / contents
Material	Aluminum	Type	SMD	Mounting material
Colour	Anthracite	Replaceable	Yes	Connector F
Cable	1 m Ho5RN-F	Voltage	12 V AC/DC	Ground spike
Length	100 mm	Start-up voltage	9 V	Hex key
Width	60 mm	Wattage	2,5 W	
Height	95 mm	Lumen output	200 lm	
Drillhole	-	Light colour (CCT)	3.000 K	<b>Light beam / -effect</b> 
IP Class	IP44	Light angle	40°	
Protection class	III	Average lifetime	20.000 hours	
		CRI	84	
		Switch on/off	10.000	
		Dimmable	No	
		Energy class	A++	

## Castor 4

Article number 1785 | EAN code 5907800859898 | HS Code 94054091 | Warranty 5 Years

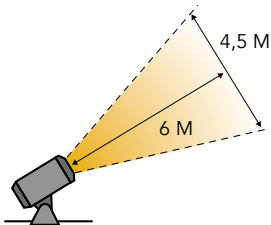
Product		Light source		Supplied accessories / contents
Material	Aluminum	Type	SMD	Mounting material
Colour	Anthracite	Replaceable	Yes	Connector F
Cable	1 m Ho5RN-F	Voltage	12 V AC/DC	Ground spike
Length	100 mm	Start-up voltage	9 V	Hex key
Width	60 mm	Wattage	3,5 W	
Height	95 mm	Lumen output	40 - 400 lm	
Drillhole	-	Light colour (CCT)	3.000 K	<b>Light beam / -effect</b> 
IP Class	IP44	Light angle	40°	
Protection class	III	Average lifetime	20.000 hours	
		CRI	81	
		Switch on/off	10.000	
		Dimmable	Yes	
		Energy class	A+	

## Castor 8

Article number 1795 | EAN code 5907800859904 | HS Code 94054091 | Warranty 5 Years

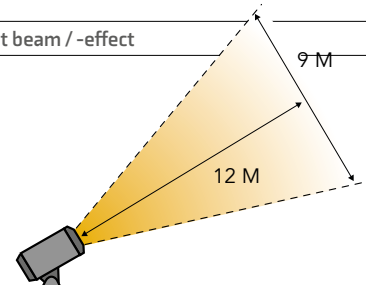
Product		Light source		Supplied accessories / contents
Material	Aluminum	Type	SMD	Mounting material
Colour	Anthracite	Replaceable	Yes	Connector F
Cable	1 m Ho5RN-F	Voltage	12 V AC/DC	Ground spike
Length	120 mm	Start-up voltage	7 V	Hex key
Width	60 mm	Wattage	8 W	
Height	95 mm	Lumen output	80 - 800 lm	
Drillhole	-	Light colour (CCT)	3.000 K	<b>Light beam / -effect</b> 
IP Class	IP44	Light angle	40°	
Protection class	III	Average lifetime	20.000 hours	
		CRI	82	
		Switch on/off	10.000	
		Dimmable	Yes	
		Energy class	A+	



## Castor 9

Article number 1805 | EAN code 5907800859911 | HS Code 94054091 | Warranty 5 Years

Product		Light source		Supplied accessories / contents
Material	Aluminum	Type	COB	Mounting material
Colour	Anthracite	Replaceable	Yes	Connector F
Cable	1 m Ho5RN-F	Voltage	12 V AC/DC	Ground spike
Length	120 mm	Start-up voltage	9 V	Hex key
Width	60 mm	Wattage	9 W	Extra Reflector
Height	95 mm	Lumen output	65 - 750 lm	
Drillhole	-	Light colour (CCT)	3.000 K	<b>Light beam / -effect</b>
IP Class	IP44	Light angle	30° / 60°	
Protection class	III	Average lifetime	20.000 hours	
		CRI	91	
		Switch on/off	10.000	
		Dimmable	Yes	
		Energy class	A+	

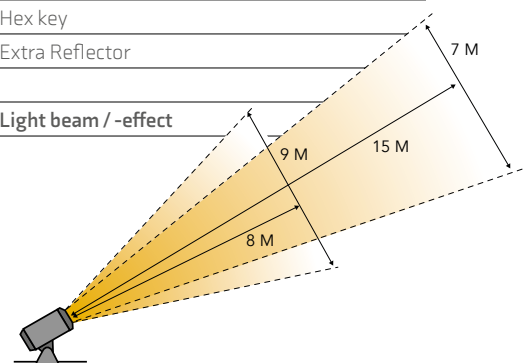

## Juno 2

Article number 1935 | EAN code 8719979280826 | HS Code 94054091 | Warranty 5 Years

Product		Light source		Supplied accessories / contents
Material	Aluminum	Type	SMD	Mounting material
Colour	Anthracite	Replaceable	No	Connector F
Cable	2m AWM2464	Voltage	12 V AC/DC	Ground spike
Length	68 mm	Start-up voltage	9 V	Hex key
Width	55 mm	Wattage	1,5 W	
Height	85 mm	Lumen output	192 lm	
Drillhole	-	Light colour (CCT)	3.000 K	<b>Light beam / -effect</b>
IP Class	IP65	Light angle	30°	
Protection class	III	Average lifetime	20.000 hours	
		CRI	83	
		Switch on/off	10.000	
		Dimmable	No	
		Energy class	A++	

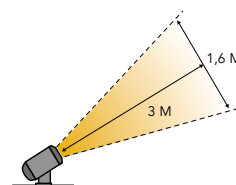

## Juno 4

Article number 1945 | EAN code 8719979280833 | HS Code 94054091 | Warranty 5 Years

Product		Light source		Supplied accessories / contents
Material	Aluminum	Type	SMD	Mounting material
Colour	Anthracite	Replaceable	No	Connector F
Cable	2m AWM2464	Voltage	12 V AC/DC	Ground spike
Length	68 mm	Start-up voltage	9 V	Hex key
Width	55 mm	Wattage	4 W	
Height	85 mm	Lumen output	372 lm	
Drillhole	-	Light colour (CCT)	3.000 K	<b>Light beam / -effect</b>
IP Class	IP65	Light angle	30°	
Protection class	III	Average lifetime	20.000 hours	
		CRI	83	
		Switch on/off	10.000	
		Dimmable	No	
		Energy class	A++	

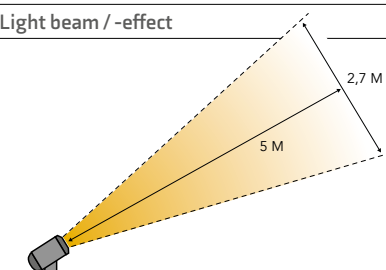

# Nilus

Article number 210S | EAN code 8719979282127 | HS Code 94054091 | Warranty 5 Years

Product		Light source		Supplied accessories / contents
Material	ABS	Type	SMD	Connector F
Colour	Black/Anthracite	Replaceable	No	
Cable	5 m Ho5RN-F	Voltage	12 V AC/DC	
Length	109 mm	Start-up voltage	9 V	
Width	95 mm	Wattage	4 W	
Height	129 mm	Lumen output	400 lm	
Drillhole	-	Light colour (CCT)	3.000 K	Light beam / -effect
IP Class	IP68	Light angle	30°	
Protection class	III	Average lifetime	20.000 hours	
		CRI	82	
		Switch on/off	10.000	
		Dimmable	No	
		Energy class	A+	

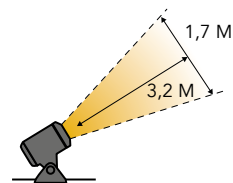

20 M

15 M

10 M

5 M



Castor g

Avior

The object you want to illuminate is the key determiner when selecting the right spotlight. So take a good look at how much light output is needed to illuminate your entire tree or shrub.

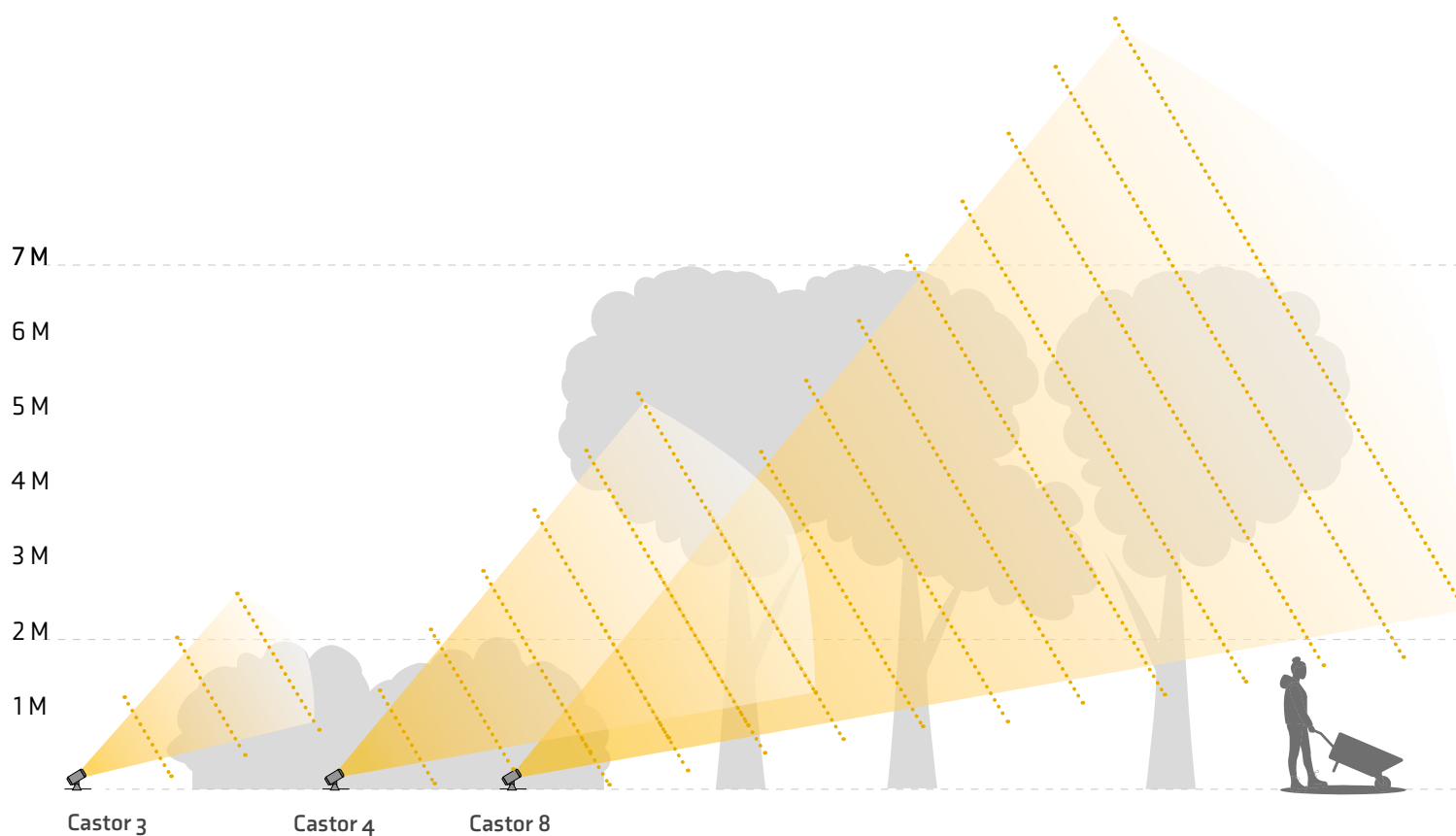
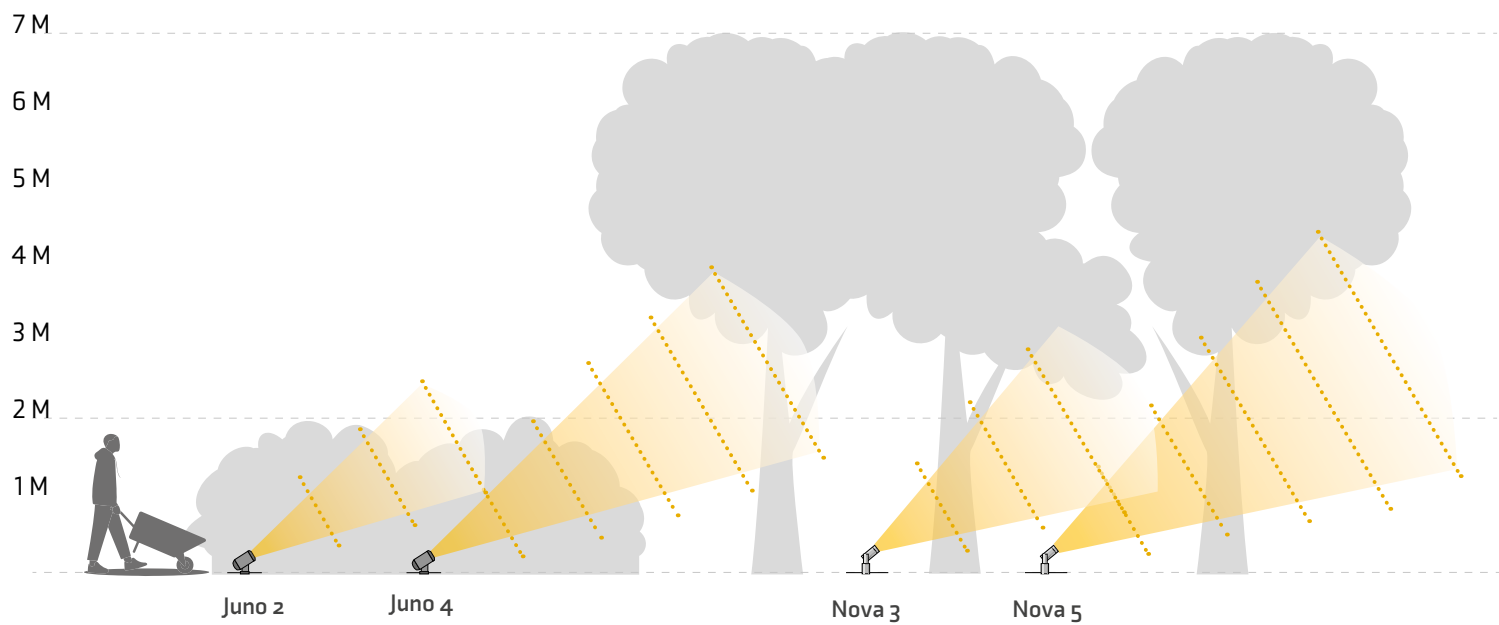

# Wall lighting

## Polaris

Article number 185W | EAN code 5907800859966 | HS Code 94054091 | Warranty 5 Years

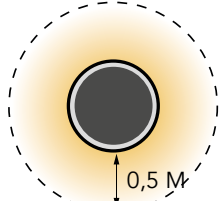
Product		Light source		Supplied accessories / contents
Material	Aluminum	Type	SMD	Mounting material
Colour	Anthracite	Replaceable	No	Connector F
Cable	3m SPT-1W	Voltage	12 V AC/DC	
		Start-up voltage	9 V	
Length	35 mm	Wattage	6 W	
Diameter	145 mm	Lumen output	495 lm	
Drillhole	-	Light colour (CCT)	3.000 K	Light beam / -effect
IP Class	IP44	Light angle	360°	
Protection class	III	Average lifetime	20.000 hours	
		CRI	83	
		Switch on/off	10.000	
		Dimmable	No	
		Energy class	A+	

## Kuma

Article number 184W | EAN code 5907800859959 | HS Code 94054091 | Warranty 5 Years

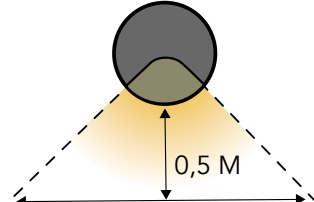
Product		Light source		Supplied accessories / contents
Material	Aluminum	Type	SMD	Mounting material
Colour	Anthracite	Replaceable	No	Connector F
Cable	3m SPT-1W	Voltage	12 V AC/DC	
		Start-up voltage	9 V	
Length	35 mm	Wattage	6 W	
Diameter	145 mm	Lumen output	294 lm	
Drillhole	-	Light colour (CCT)	3.000 K	Light beam / -effect
IP Class	IP44	Light angle	90°	
Protection class	III	Average lifetime	20.000 hours	
		CRI	83	
		Switch on/off	10.000	
		Dimmable	No	
		Energy class	A	

## Ixion

Article number 182W | EAN code 5907800859935 | HS Code 94054091 | Warranty 5 Years

Product		Light source		Supplied accessories / contents
Material	Aluminum	Type	COB	Mounting material
Colour	Anthracite	Replaceable	No	Connector F
Cable	3m SPT-1W	Voltage	12 V AC/DC	Hex key
Length	110 mm	Start-up voltage	9 V	
Width	110 mm	Wattage	9 W	
Height	110 mm	Lumen output	50 - 534 lm	
Drillhole	-	Light colour (CCT)	3.000 K	Light beam / -effect
IP Class	IP44	Light angle	0 - 90°	
Protection class	III	Average lifetime	20.000 hours	
		CRI	84	
		Switch on/off	10.000	
		Dimmable	Yes	
		Energy class	A	

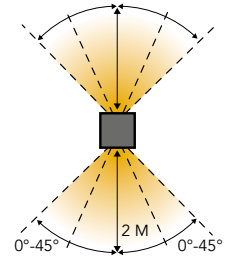

## Quartz

Article number 196W | EAN code 8719979281083 | HS Code 94054091 | Warranty 5 Years

Product		Light source		Supplied accessories / contents
Material	Aluminum	Type	MR11	Mounting material
Colour	Black	Replaceable	Yes	Connector F
Cable	3m SPT-1W	Voltage	12 V AC/DC	Ground spike
Length	85 mm	Start-up voltage	9 V	
Width	50 mm	Wattage	2 W	
Height	105 mm	Lumen output	120 lm	
Drillhole	-	Light colour (CCT)	3.000 K	Light beam / -effect
IP Class	IP44	Light angle	30°	
Protection class	III	Average lifetime	20.000 hours	
		CRI	83	
		Switch on/off	10.000	
		Dimmable	No	
		Energy class	A+	

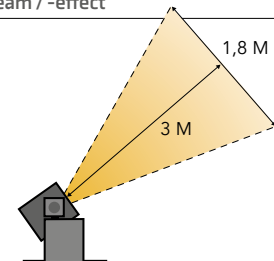

# Up- & Decklights

## Onyx 30 R1

Article number 150D | EAN code 5907800857993 | HS Code 94054091 | Warranty 5 Years

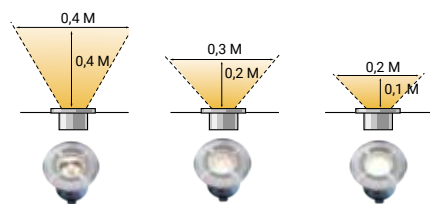
Product		Light source		Supplied accessories / contents
Material	Stainless steel 316	Type	SMD	Extra glasses
Colour	Stainless steel	Replaceable	No	Connector F
Cable	1 m. H05RN-F	Voltage	12 V AC/DC	
		Start-up voltage	9 V	
Diameter	45 mm	Wattage	0,5 W	
Height	41 mm	Lumen output	4 lm	
Drillhole	30 mm	Light colour (CCT)	2,700 K	<b>Light beam / -effect</b> 
IP Class	IP67	Light angle	-	
Protection class	III	Average lifetime	20.000 hours	
Can be driven over	Yes (car)	CRI	83	
		Switch on/off	10.000	
		Dimmable	No	
		Energy class	-	

## Onyx 60 R1

Article number 151D | EAN code 5907800858006 | HS Code 94054091 | Warranty 5 Years

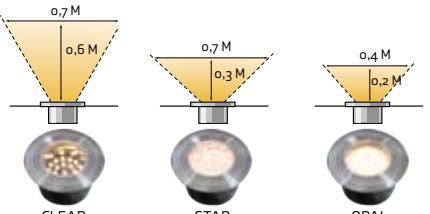
Product		Light source		Supplied accessories / contents
Material	Stainless steel 316	Type	SMD	Extra glasses
Colour	Stainless steel	Replaceable	No	Connector F
Cable	1 m. H05RN-F	Voltage	12 V AC/DC	
		Start-up voltage	9 V	
Diameter	75 mm	Wattage	1 W	
Height	42 mm	Lumen output	23 lm	
Drillhole	60 mm	Light colour (CCT)	2,700 K	<b>Light beam / -effect</b> 
IP Class	IP67	Light angle	-	
Protection class	III	Average lifetime	20.000 hours	
Can be driven over	Yes (car)	CRI	84	
		Switch on/off	10.000	
		Dimmable	No	
		Energy class	-	

## Onyx 60 R3

Article number 153D | EAN code 5907800858020 | HS Code 94054091 | Warranty 5 Years

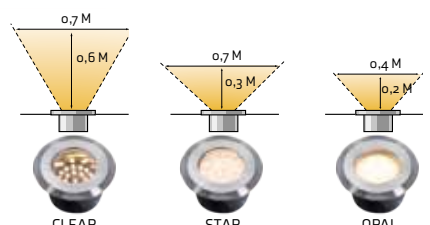
Product		Light source		Supplied accessories / contents
Material	Stainless steel 316	Type	SMD	Extra glasses
Colour	Stainless steel	Replaceable	No	Connector F
Cable	1 m. H05RN-F	Voltage	12 V AC/DC	
		Start-up voltage	9 V	
Diameter	75 mm	Wattage	1 W	
Height	42 mm	Lumen output	23 lm	
Drillhole	60 mm	Light colour (CCT)	2,700 K	<b>Light beam / -effect</b> 
IP Class	IP67	Light angle	-	
Protection class	III	Average lifetime	20.000 hours	
Can be driven over	Yes (car)	CRI	84	
		Switch on/off	10.000	
		Dimmable	No	
		Energy class	-	

## Onyx 60 R4

Article number 154D | EAN code 5907800858037 | HS Code 94054091 | Warranty 5 Years

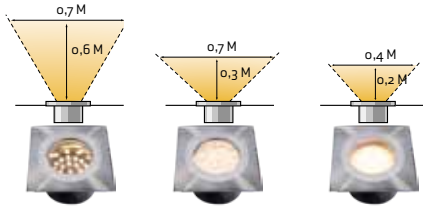
Product		Light source		Supplied accessories / contents
Material	Stainless steel 316	Type	SMD	Extra glasses
Colour	Stainless steel	Replaceable	No	Connector F
Cable	1 m. H05RN-F	Voltage	12 V AC/DC	
Length	75 mm	Start-up voltage	9 V	
Width	75 mm	Wattage	1 W	
Height	42 mm	Lumen output	23 lm	
Drillhole	60 mm	Light colour (CCT)	2,700 K	<b>Light beam / -effect</b> 
IP Class	IP67	Light angle	-	
Protection class	III	Average lifetime	20.000 hours	
Can be driven over	Yes (car)	CRI	84	
		Switch on/off	10.000	
		Dimmable	No	
		Energy class	-	

## Onyx 90 R1

Article number 156D | EAN code 5907800858051 | HS Code 94054091 | Warranty 5 Years

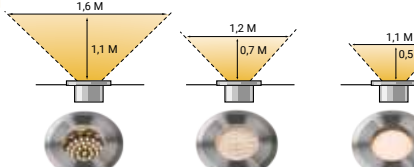
Product		Light source		Supplied accessories / contents
Material	Stainless steel 316	Type	SMD	Extra glasses
Colour	Stainless steel	Replaceable	No	Connector F
Cable	1 m. H05RN-F	Voltage	12 V AC/DC	
		Start-up voltage	9 V	
Diameter	105 mm	Wattage	1,5 W	
Height	43 mm	Lumen output	76 / 38 / 20 lm	
Drillhole	90 mm	Light colour (CCT)	2,700 K	<b>Light beam / -effect</b> 
IP Class	IP67	Light angle	-	
Protection class	III	Average lifetime	20.000 hours	
Can be driven over	Yes (car)	CRI	84	
		Switch on/off	10.000	
		Dimmable	No	
		Energy class	A+	

## Nomia

Article number 207U | EAN code 8719979282097 | HS Code 94054091 | Warranty 5 Years

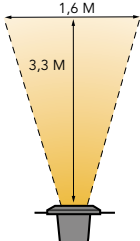
Product		Light source		Supplied accessories / contents
Material	Aluminum	Type	SMD	Ground tube
Colour	Black	Replaceable	No	Connector F
Cable	1 m. H05RN-F	Voltage	12 V AC/DC	
		Start-up voltage	9 V	
Diameter	90 mm	Wattage	3 W	
Height	86 mm	Lumen output	313 lm	
Drillhole	70 mm	Light colour (CCT)	3,000 K	<b>Light beam / -effect</b> 
IP Class	IP67	Light angle	30°	
Protection class	III	Average lifetime	20.000 hours	
Can be driven over	No	CRI	82	
		Switch on/off	10.000	
		Dimmable	No	
		Energy class	A+	

# Up- & Decklights

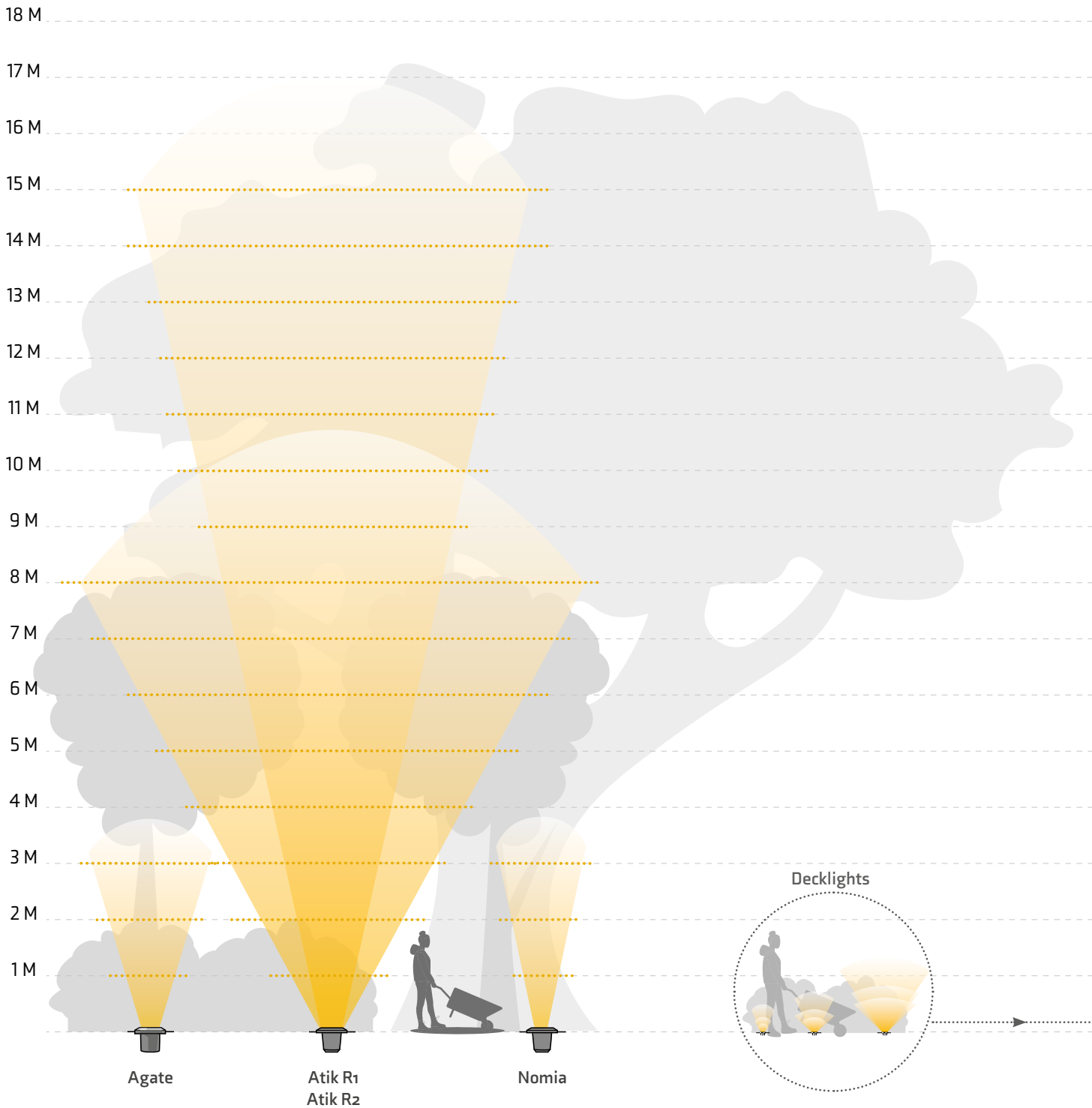



# LED Strip

Article number 175L | EAN code 5907800859850 | HS Code 94054039 | Warranty 5 Years

Product		Light source		Supplied accessories / contents
Material	Synthetic	Type	SMD	Excl. LED Strip Connector[211L]
Colour	White	Replaceable	No	
Cable	-	Voltage	12 V AC/DC	
Length	15 m	Start-up voltage	9 V	
Width	10 mm	Wattage	2,2 W / m	
Height	15 mm	Lumen output	80 lm / m	
Drillhole	-	Light colour (CCT)	3.000 K	Light beam / -effect
IP Class	IP67	Light angle	-	
Protection class	III	Average lifetime	20.000 hours	
		CRI	81	
		Switch on/off	10.000	
		Dimmable	No	
		Energy class	A	

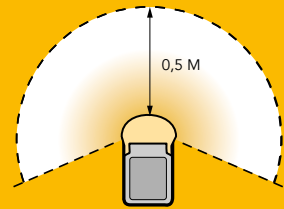

Decklights are most commonly used as orientation lights. In the image below you can easily compare the different decklights and select the right one.

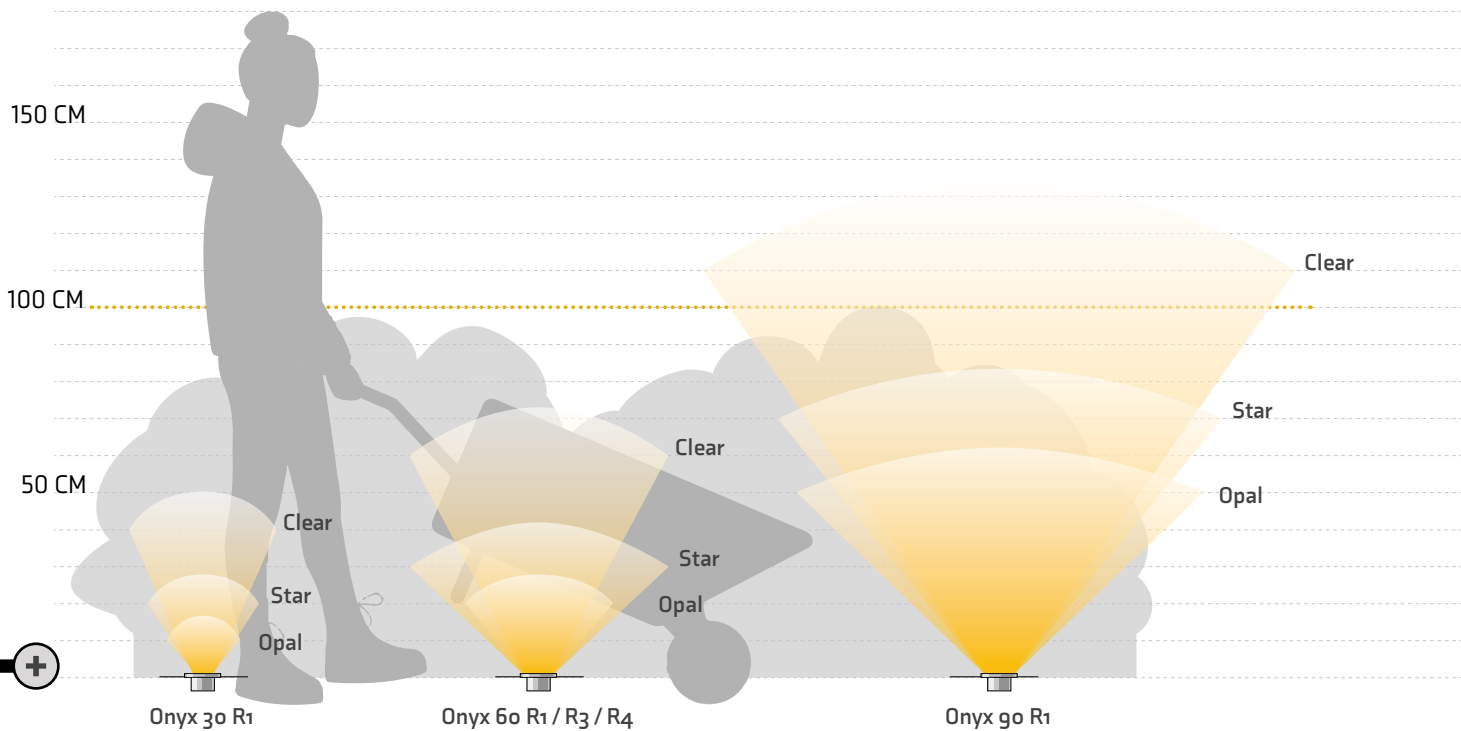

## Atik R1

Article number 186U | EAN code 5907800859973 | HS Code 94054091 | Warranty 5 Years

Product		Light source		Supplied accessories / contents
Material	Aluminum	Type	COB	Ground tube
Colour	Anthracite	Replaceable	No	Connector F
Cable	1 m. H05RN-F	Voltage	12 V AC/DC	Hex key
		Start-up voltage	9 V	Extra Reflector
Diameter	120 mm	Wattage	9 W	
Height	115 mm	Lumen output	750 lm	
Drillhole	100 mm	Light colour (CCT)	3.000 K	<b>Light beam / -effect</b>
IP Class	IP67	Light angle	23° / 60°	
Protection class	III	Average lifetime	20.000 hours	
Can be driven over	No	CRI	92	
		Switch on/off	10.000	
		Dimmable	Yes	
		Energy class	A+	

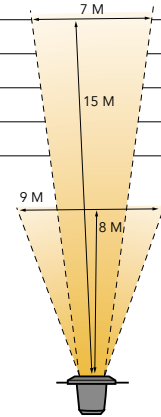

## Atik R2

Article number 187U | EAN code 5907800859980 | HS Code 94054091 | Warranty 5 Years

Product		Light source		Supplied accessories / contents
Material	Stainless steel 316	Type	COB	Ground tube
Colour	Gray	Replaceable	No	Connector F
Cable	1 m. H05RN-F	Voltage	12 V AC/DC	Hex key
		Start-up voltage	9 V	Extra Reflector
Diameter	120 mm	Wattage	9 W	
Height	115 mm	Lumen output	750 lm	
Drillhole	100 mm	Light colour (CCT)	3.000 K	<b>Light beam / -effect</b>
IP Class	IP67	Light angle	23° / 60°	
Protection class	III	Average lifetime	20.000 hours	
Can be driven over	Nein	CRI	92	
		Switch on/off	10.000	
		Dimmable	Yes	
		Energy class	A+	

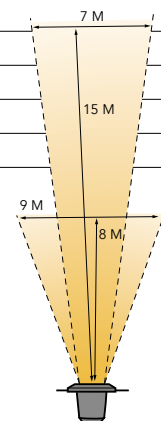

## Agate

Article number 102U | EAN code 5907800856774 | HS Code 94054091 | Warranty 5 Years

Product		Light source		Supplied accessories / contents
Material	Stainless steel 316	Type	MR16	Ground tube
Colour	Gray	Replaceable	Yes	Connector F
Cable	1 m. H05RN-F	Voltage	12 V AC/DC	Hex key
		Start-up voltage	9 V	
Diameter	113 mm	Wattage	3 W	
Height	113 mm	Lumen output	190 lm	
Drillhole	90 mm	Light colour (CCT)	3.000 K	<b>Light beam / -effect</b>
IP Class	IP67	Light angle	40°	
Protection class	III	Average lifetime	20.000 hours	
Can be driven over	Yes (car)	CRI	84	
		Switch on/off	10.000	
		Dimmable	No	
		Energy class	A+	

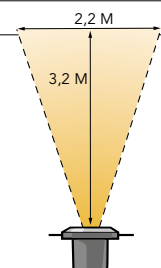





[lightpro.nl/en](https://lightpro.nl/en)