



Collection 2020
Standing lights
Spotlights
Wall lights
Uplights
Decklights



LiGHTPRO
PROFESSIONAL OUTDOOR LIGHTING

Professional outdoor lighting



Our Lightpro 12 volt outdoor lighting is designed specifically for professional use. The system is quick and easy to install and is very safe to use.



LIGHTPRO
PROFESSIONAL OUTDOOR LIGHTING

00.

The system





Explanation Lightpro system

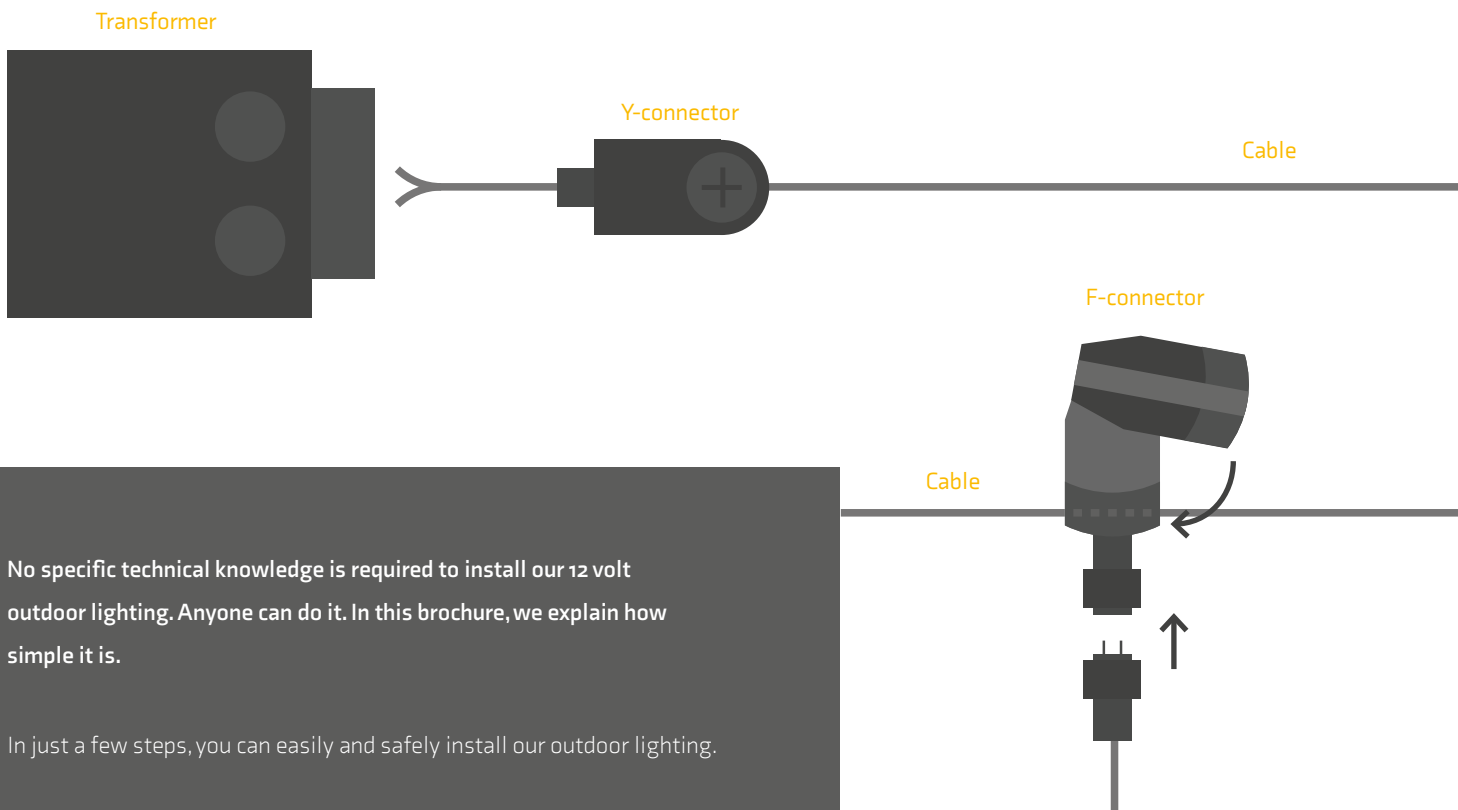

No specific technical knowledge is required to install our 12 volt outdoor lighting. Anyone can do it. In this brochure, we explain how simple it is.

In just a few steps, you can easily and safely install our outdoor lighting.

The lights and cable

1. Place the lights in the desired location.
2. Roll out the cables alongside the lights.
3. Connect the F-connector to the main cable and position the lights.
4. Plug the lighting cable into the F-connector.

The transformer

5. Insert the end of the main cable into the Y-connector.
6. Connect the Y-connector to the transformer.
7. Plug the transformer into the wall outlet.

Branch off the cable

1. Place an extra cable near the main cable.
2. Connect the F-connector to the main cable.
3. Connect the M-connector to the branch cable.
4. Complete the branch by joining the connectors.

Do you need further instructions? Please check out the videos on our website.

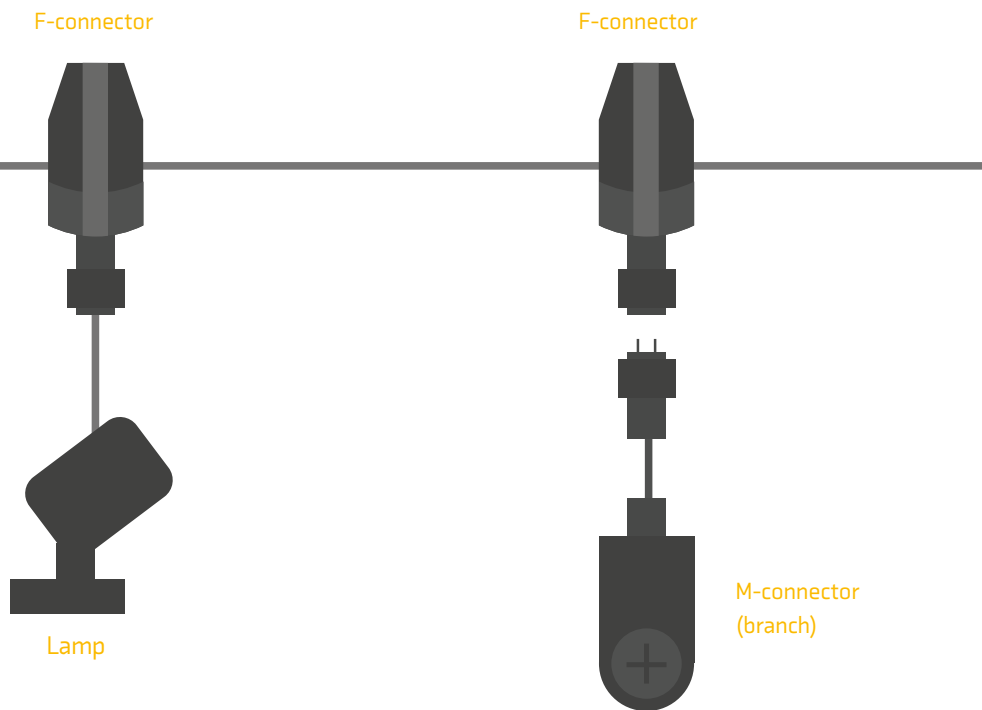

The advantages of our 12 volt system:

- Energy-efficient and durable
- Easy and quick to connect
- No buried cables
- Safe for children and animals

NEW

Explanation Lightpro Smart

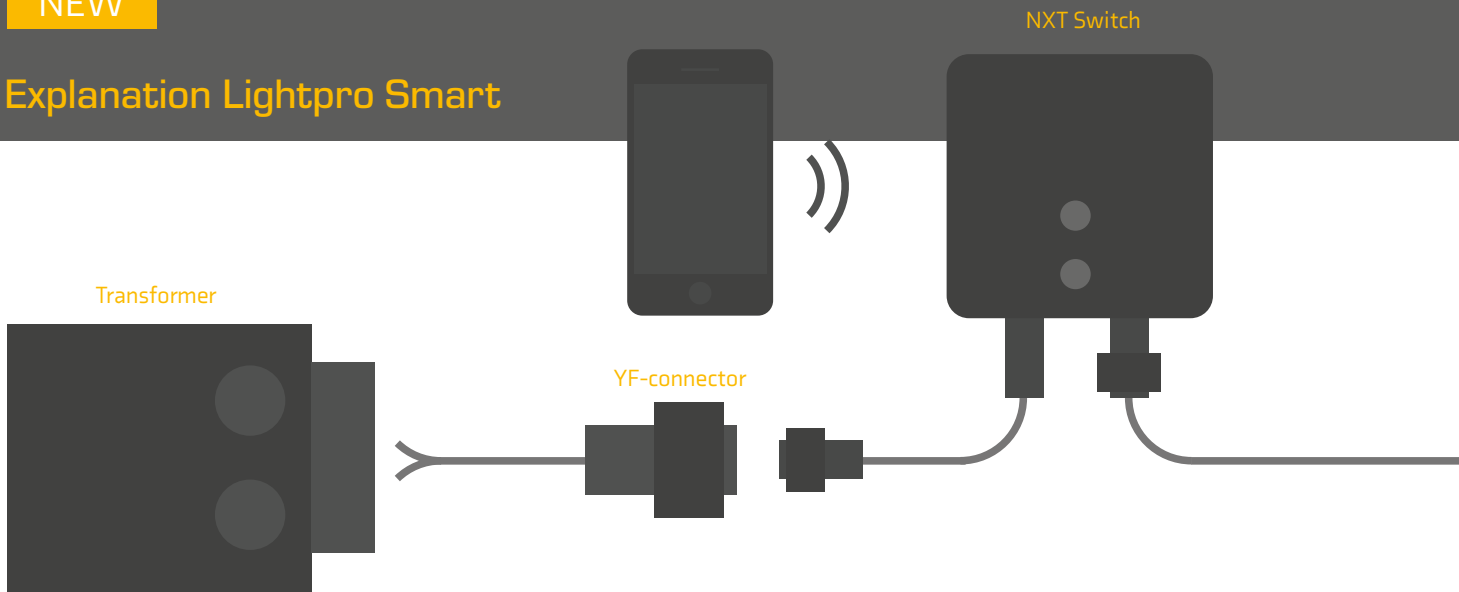

NEW: Lightpro NXT

Lightpro NXT is the solution for when you want to make your garden SMART using the Lightpro 12 volt lamps. It's as simple as the Lightpro system itself. All you have to do is add the Lightpro NXT Switch.

With the Lightpro app you can easily create zones in the garden and switch them on and off independently from each other. Or create a scene and set one or more timers.

Step-by-step plan:

The Lightpro NXT Switch can be connected to your garden lighting in different ways.

1. Place the NXT Switch between the transformer and the main cable to control your complete system as a single zone.
2. Place the NXT Switch on a branch to control only part of your system.
3. Place the NXT Switch on each branch to split your system into different zones.



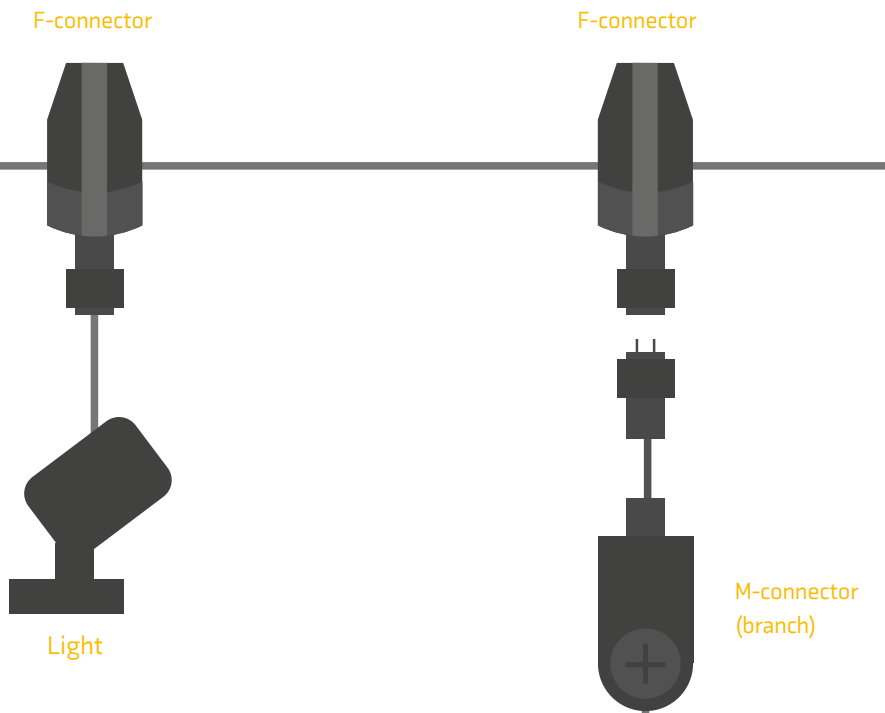

01.

Standing lights

Lightpro standing lights create a suitable atmosphere around the house. Our range shows different styles that are perfect for illuminating driveways, paths, borders and terraces.



Standing lights



Opal

Aluminium - Anthracite

LED 3W

3.000K - 190lm



Barite DL

Aluminium - Black

LED 3W

3.000K - 130lm

Standing lights in different styles

Luminaires that provide light from all directions, for example, are great for illuminating plants. Luminaires that provide direct light are very suitable for paths or driveways. A number of

luminaires are equipped with a dimmer. They can be recognised by the 'dimnable' logo. Dimmable luminaires provide 6 intensities for the user to decide which is best suited to a specific situation. Ideal for the different seasons of the year!



NEW

Oberon Lo

Aluminium - Anthracite

LED 4W
3.000K - 400lm



NEW

Oberon Hi

Aluminium - Anthracite

LED 4W
3.000K - 400lm



Barite 40

Aluminium - Black

LED 3W
3.000K - 190lm



Barite 60

Aluminium - Black

LED 3W
3.000K - 190lm



Nina

Stainless steel 316

LED 3W
3.000K - 190lm



Nodin

Stainless steel 316

LED 3W
3.000K - 190lm

A connector is supplied as standard with each light.

Standing lights



Oberon Hi



Oberon Lo



Barite DL



Nina

Opal

Article number 115P | EAN code 5907800856903 | HS code 94054091 | Warranty 5 Years

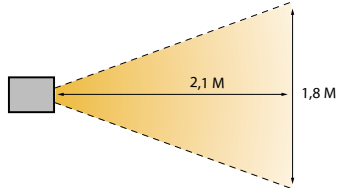
Product		Light source		Supplied accessories / contents
Material	Aluminium	Type	MR16	Mounting material
Colour	Grey	Replaceable	Yes	F connector
Cable	1 m. Ho5RN-F	Voltage	12 V AC/DC	
Depth	165 mm	Start-up voltage	9 V	
Width	65 mm	Wattage	3 W	
Height	705 mm	Lumen output	190 lm	
Drillhole	-	Light colour (CCT)	3.000 K	Light beam / -effect
IP class	IP44	Light angle	-	
Protection class	III	Average lifetime	20.000 hours	
		CRI	84	
		Switch on / off	10.000	
		Dimmable	No	
		Energy class	A+	

Oberon Lo

Article number 190P | EAN code 8719979280796 | HS code 94054091 | Warranty 5 Years

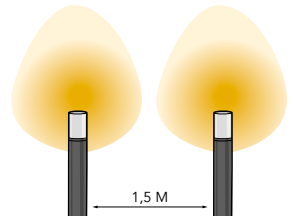
Product		Light source		Supplied accessories / contents
Material	Aluminium	Type	SMD	Mounting material
Colour	Anthracite	Replaceable	No	F connector
Cable	1 m. Ho5RN-F	Voltage	12 V AC/DC	Ground spike
		Start-up voltage	9 V	Foam ring
Diameter	64 mm	Wattage	4 W	Hex key
Height	420 mm	Lumen output	400 lm	
Drillhole	-	Light colour (CCT)	3.000 K	Light beam / -effect
IP class	IP44	Light angle	-	
Protection class	III	Average lifetime	20.000 hours	
		CRI	82	
		Switch on / off	10.000	
		Dimmable	Yes, built-in	
		Energy class	A+	

Oberon Hi

Article number 191P | EAN code 8719979280802 | HS code 94054091 | Warranty 5 Years

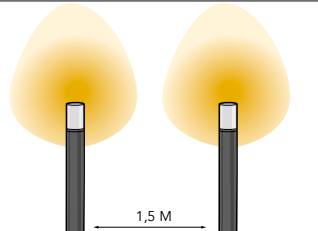
Product		Light source		Supplied accessories / contents
Material	Aluminium	Type	SMD	Mounting material
Colour	Anthracite	Replaceable	No	F connector
Cable	1 m. Ho5RN-F	Voltage	12 V AC/DC	Ground spike
		Start-up voltage	9 V	Foam ring
Diameter	64 mm	Wattage	4 W	Hex key
Height	660 mm	Lumen output	400 lm	
Drillhole	-	Light colour (CCT)	3.000 K	Light beam / -effect
IP class	IP44	Light angle	-	
Protection class	III	Average lifetime	20.000 hours	
		CRI	82	
		Switch on / off	10.000	
		Dimmable	Yes, built-in	
		Energy class	A+	

Barite DL

Article number 139P | EAN code 5907800857535 | HS code 94054091 | Warranty 5 Years

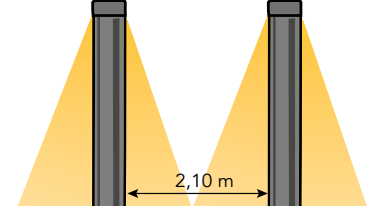
Product		Light source		Supplied accessories / contents
Material	Aluminium	Type	SMD	Mounting material
Colour	Black	Replaceable	Yes	F connector
Cable	1 m. Ho5RN-F	Voltage	12 V AC/DC	Foam ring
Depth	145 mm	Start-up voltage	9 V	Ground spike
Width	65 mm	Wattage	3 W	Hex key
Height	495 mm	Lumen output	130 lm	
Drillhole	-	Light colour (CCT)	3.000 K	Light beam / -effect
IP class	IP44	Light angle	-	
Protection class	III	Average lifetime	20.000 hours	
		CRI	76	
		Switch on / off	10.000	
		Dimmable	No	
		Energy class	A	

Barite 40

Article number 112P | EAN code 5907800856873 | HS code 94054091 | Warranty 5 Years

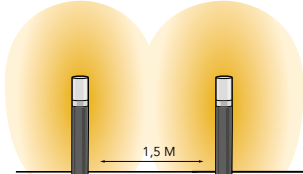
Product		Light source		Supplied accessories / contents
Material	Aluminium	Type	MR16	Mounting material
Colour	Black	Replaceable	Yes	F connector
Cable	1 m. Ho5RN-F	Voltage	12 V AC/DC	Foam ring
		Start-up voltage	9 V	Ground spike
Diameter	65 mm	Wattage	3 W	Hex key
Height	405 mm	Lumen output	190 lm	
Drillhole	-	Light colour (CCT)	3.000 K	Light beam / -effect
IP class	IP44	Light angle	-	
Protection class	III	Average lifetime	20.000 hours	
		CRI	84	
		Switch on / off	10.000	
		Dimmable	No	
		Energy class	A+	

Barite 60

Article number 111P | EAN code 5907800856866 | HS code 94054091 | Warranty 5 Years

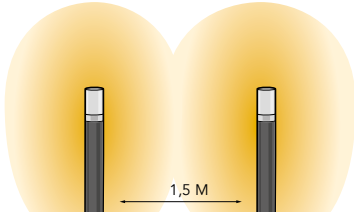
Product		Light source		Supplied accessories / contents
Material	Aluminium	Type	MR16	Mounting material
Colour	Black	Replaceable	Yes	F connector
Cable	1 m. Ho5RN-F	Voltage	12 V AC/DC	Foam ring
		Start-up voltage	9 V	Ground spike
Diameter	65 mm	Wattage	3 W	Hex key
Height	575 mm	Lumen output	190 lm	
Drillhole	-	Light colour (CCT)	3.000 K	Light beam / -effect
IP class	IP44	Light angle	-	
Protection class	III	Average lifetime	20.000 hours	
		CRI	84	
		Switch on / off	10.000	
		Dimmable	No	
		Energy class	A+	

Nina

Article number 129P | EAN code 5907800857047 | HS code 94054091 | Warranty 5 Years

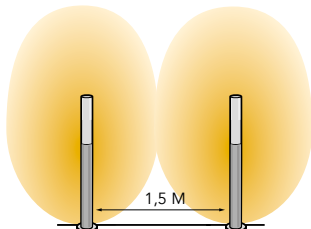
Product		Light source		Supplied accessories / contents
Material	Stainless steel 316	Type	MR16	Mounting material
Colour	Grey	Replaceable	Yes	F connector
Cable	1 m. H05RN-F	Voltage	12 V AC/DC	Ground spike
		Start-up voltage	9 V	
Diameter	105 mm	Wattage	3 W	
Height	757 mm	Lumen output	190 lm	
Drillhole	-	Light colour (CCT)	3.000 K	Light beam / -effect 
IP class	IP44	Light angle	-	
Protection class	III	Average lifetime	20.000 hours	
		CRI	84	
		Switch on / off	10.000	
		Dimmable	No	
		Energy class	A+	

Nodin

Article number 128P | EAN code 5907800857030 | HS code 94054091 | Warranty 5 Years

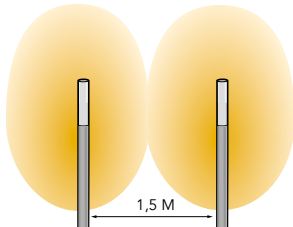
Product		Light source		Supplied accessories / contents
Material	Stainless steel 316	Type	MR16	Mounting material
Colour	Grey	Replaceable	Yes	F connector
Cable	1 m. H05RN-F	Voltage	12 V AC/DC	Ground spike
		Start-up voltage	9 V	
Diameter	105 mm	Wattage	3 W	
Height	1018 mm	Lumen output	190 lm	
Drillhole	-	Light colour (CCT)	3.000 K	Light beam / -effect 
IP class	IP44	Light angle	-	
Protection class	III	Average lifetime	20.000 hours	
		CRI	84	
		Switch on / off	10.000	
		Dimmable	No	
		Energy class	A+	



Opal

02.

Spots

Spots make for a surprising effect in the evenings

Lightpro spots create a wonderful ambience by silhouetting shrubberies, small trees and other objects. We offer spots with various light beams. If you want to silhouette a large tree, then choose our very powerful spot. If you want to try out different intensities of light, then choose our dimmable spots.



**Avior**

Aluminium - Anthracite

LED 16W

3.000K - 1500lm

**Nova 3**

Stainless steel 316

LED 3W

3.000K - 190lm

**Nova 5**

Stainless steel 316

LED 5W

3.000K - 320lm

If certain objects need slightly more focus than others, then spotlights are the perfect way to accentuate them.

By determining the right angle yourself, you can optimally highlight an object. As spots can be used for different purposes, we offer as wide a range as possible. Please take a look at the page with our

product specifications and choose a variant that best suits your project. Have you noticed our dimmable spots? They allow the light to grow along with the growth of the trees or shrubberies. Perfect for every season!



NEW

Juno 2

Aluminium - Anthracite

LED 1,5W
3.000K - 192lm



NEW

Juno 4

Aluminium - Anthracite

LED 4W
3.000K - 372lm



Castor 3

Aluminium - Anthracite

LED 2,5W
3.000K - 200lm



Castor 4

Aluminium - Anthracite

LED 3,5W
3.000K - 400lm



Castor 8

Aluminium - Anthracite

LED 8W
3.000K - 800lm



Castor 9

Aluminium - Anthracite

LED 9W
3.000K - 750lm



Castor



Castor



Nova

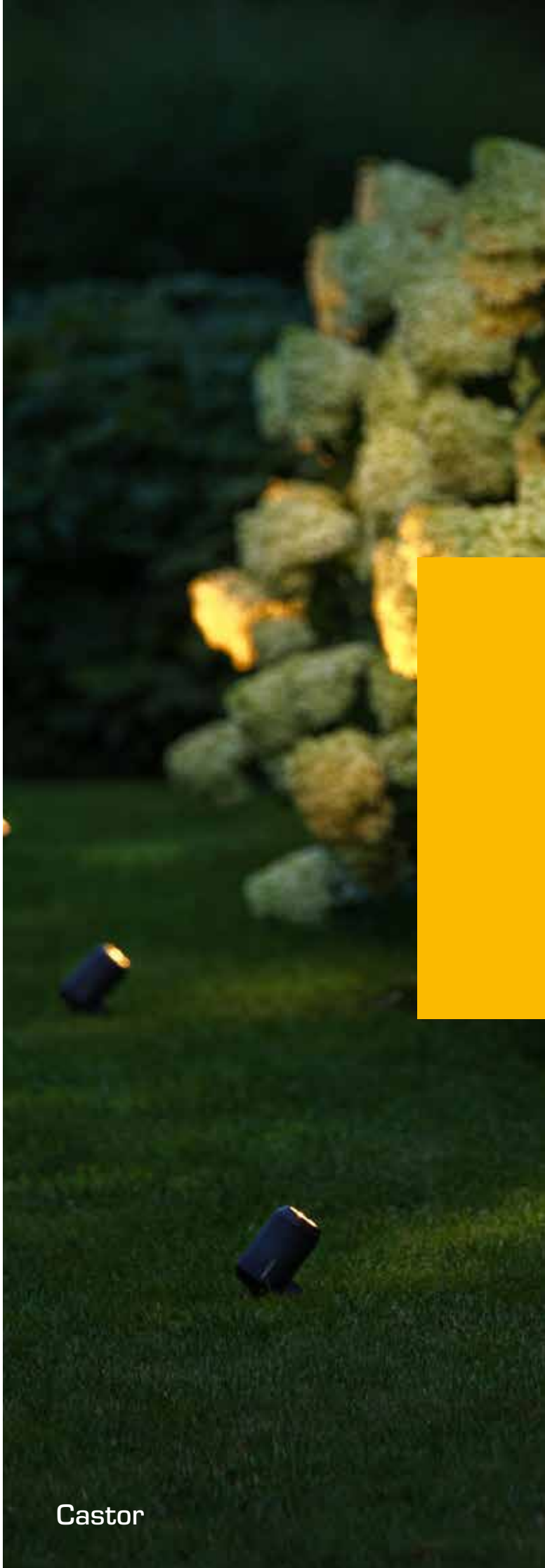

Castor

Avior

Article number 1815 | EAN code 5907800859928 | HS code 94054091 | Warranty 5 Years

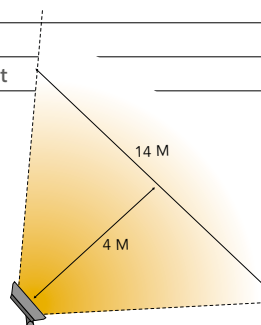
Product		Light source		Supplied accessories / contents
Material	Aluminium	Type	COB	Mounting material
Colour	Anthracite	Replaceable	No	F connector
Cable	1 m. Ho5RN-F	Voltage	12 V AC/DC	Ground spike
Depth	68 mm	Start-up voltage	9 V	Hex key
Width	180 mm	Wattage	16 W	
Height	125 mm	Lumen output	1500 lm	
Drillhole	-	Light colour (CCT)	3.000 K	Light beam / -effect 
IP class	IP44	Light angle	100°	
Protection class	III	Average lifetime	20.000 hours	
		CRI	80	
		Switch on / off	10.000	
		Dimmable	Yes, built-in	
		Energy class	A+	

Nova 3

Article number 1175 | EAN code 5907800856927 | HS code 94054091 | Warranty 5 Years

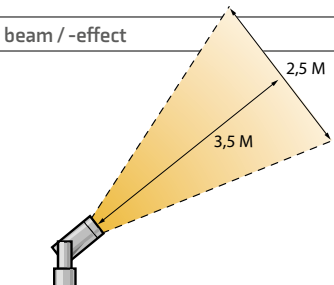
Product		Light source		Supplied accessories / contents
Material	Stainless steel 316	Type	MR11	Mounting material
Colour	Grey	Replaceable	Yes	F connector
Cable	1 m. Ho5RN-F	Voltage	12 V AC/DC	Ground spike
Depth	81 mm	Start-up voltage	9 V	
Width	77 mm	Wattage	3 W	
Height	115 mm	Lumen output	190 lm	
Drillhole	-	Light colour (CCT)	3.000 K	Light beam / -effect 
IP class	IP44	Light angle	30°	
Protection class	III	Average lifetime	20.000 hours	
		CRI	84	
		Switch on / off	10.000	
		Dimmable	No	
		Energy class	A	

Nova 5

Article number 1165 | EAN code 5907800856910 | HS code 94054091 | Warranty 5 Years

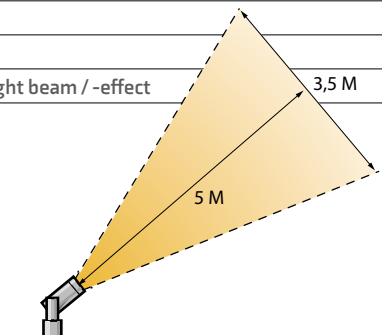
Product		Light source		Supplied accessories / contents
Material	Stainless steel 316	Type	MR16	Mounting material
Colour	Grey	Replaceable	Yes	F connector
Cable	1 m. Ho5RN-F	Voltage	12 V AC/DC	Ground spike
Depth	120 mm	Start-up voltage	9 V	
Width	100 mm	Wattage	5 W	
Height	180 mm	Lumen output	320 lm	
Drillhole	-	Light colour (CCT)	3.000 K	Light beam / -effect 
IP class	IP44	Light angle	40°	
Protection class	III	Average lifetime	20.000 hours	
		CRI	80	
		Switch on / off	10.000	
		Dimmable	No	
		Energy class	A	



Nova

Juno 2

Article number 1935 | EAN code 8719979280826 | HS code 94054091 | Warranty 5 Years

Product		Light source		Supplied accessories / contents
Material	Aluminium	Type	SMD	Mounting material
Colour	Anthracite	Replaceable	No	F connector
Cable	2m AWM2464	Voltage	12 V AC/DC	Ground spike
Depth	68 mm	Start-up voltage	9 V	Hex key
Width	55 mm	Wattage	1,5 W	
Height	85 mm	Lumen output	192 lm	
Drillhole	-	Light colour (CCT)	3.000 K	Light beam / -effect
IP class	IP65	Light angle	30°	
Protection class	III	Average lifetime	20.000 hours	
		CRI	83	
		Switch on / off	10.000	
		Dimmable	No	
		Energy class	A++	

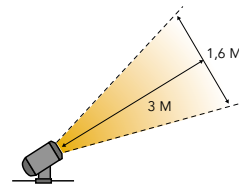

Juno 4

Article number 1945 | EAN code 8719979280833 | HS code 94054091 | Warranty 5 Years

Product		Light source		Supplied accessories / contents
Material	Aluminium	Type	SMD	Mounting material
Colour	Anthracite	Replaceable	No	F connector
Cable	2m AWM2464	Voltage	12 V AC/DC	Ground spike
Depth	68 mm	Start-up voltage	9 V	Hex key
Width	55 mm	Wattage	4 W	
Height	85 mm	Lumen output	372 lm	
Drillhole	-	Light colour (CCT)	3.000 K	Light beam / -effect
IP class	IP65	Light angle	30°	
Protection class	III	Average lifetime	20.000 hours	
		CRI	83	
		Switch on / off	10.000	
		Dimmable	No	
		Energy class	A++	

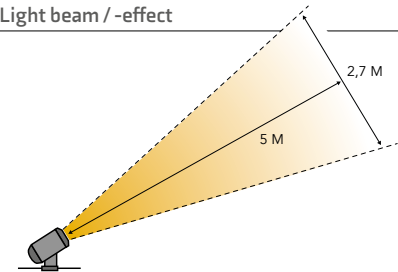

Castor 3

Article number 1775 | EAN code 5907800859881 | HS code 94054091 | Warranty 5 Years

Product		Light source		Supplied accessories / contents
Material	Aluminium	Type	SMD	Mounting material
Colour	Anthracite	Replaceable	Yes	F connector
Cable	1 m Ho5RN-F	Voltage	12 V AC/DC	Ground spike
Length	100 mm	Start-up voltage	9 V	Hex key
Width	60 mm	Wattage	2,5 W	
Height	95 mm	Lumen output	200 lm	
Drillhole	-	Light colour (CCT)	3.000 K	Light beam / -effect
IP class	IP44	Light angle	40°	
Protection class	III	Average lifetime	20.000 hours	
		CRI	84	
		Switch on / off	10.000	
		Dimmable	No	
		Energy class	A++	

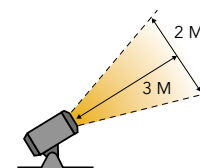

Castor 4

Article number 1785 | EAN code 5907800859898 | HS code 94054091 | Warranty 5 Years

Product		Light source		Supplied accessories / contents
Material	Aluminium	Type	SMD	Mounting material
Colour	Anthracite	Replaceable	Yes	F connector
Cable	1 m Ho5RN-F	Voltage	12 V AC/DC	Ground spike
Length	100 mm	Start-up voltage	9 V	Hex key
Width	60 mm	Wattage	3,5 W	
Height	95 mm	Lumen output	400 lm	
Drillhole	-	Light colour (CCT)	3.000 K	Light beam / -effect
IP class	IP44	Light angle	40°	
Protection class	III	Average lifetime	20.000 hours	
		CRI	81	
		Switch on / off	10.000	
		Dimmable	Yes, built-in	
		Energy class	A+	

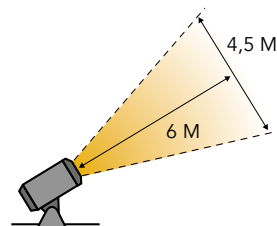

Castor 8

Article number 1795 | EAN code 5907800859904 | HS code 94054091 | Warranty 5 Years

Product		Light source		Supplied accessories / contents
Material	Aluminium	Type	SMD	Mounting material
Colour	Anthracite	Replaceable	Yes	F connector
Cable	1 m Ho5RN-F	Voltage	12 V AC/DC	Ground spike
Length	120 mm	Start-up voltage	7 V	Hex key
Width	60 mm	Wattage	8 W	
Height	95 mm	Lumen output	800 lm	
Drillhole	-	Light colour (CCT)	3.000 K	Light beam / -effect
IP class	IP44	Light angle	40°	
Protection class	III	Average lifetime	20.000 hours	
		CRI	82	
		Switch on / off	10.000	
		Dimmable	Yes, built-in	
		Energy class	A+	

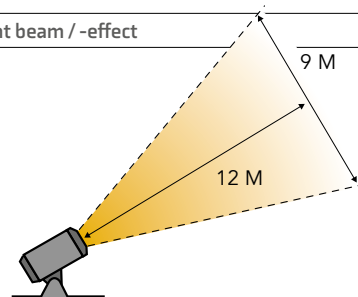

Castor 9

Article number 1805 | EAN code 5907800859911 | HS code 94054091 | Warranty 5 Years

Product		Light source		Supplied accessories / contents
Material	Aluminium	Type	COB	Mounting material
Colour	Anthracite	Replaceable	Yes	F connector
Cable	1 m Ho5RN-F	Voltage	12 V AC/DC	Ground spike
Length	120 mm	Start-up voltage	9 V	Hex key
Width	60 mm	Wattage	9 W	Extra Reflector
Height	95 mm	Lumen output	750 lm	
Drillhole	-	Light colour (CCT)	3.000 K	Light beam / -effect
IP class	IP44	Light angle	30° / 60°	
Protection class	III	Average lifetime	20.000 hours	
		CRI	91	
		Switch on / off	10.000	
		Dimmable	Yes, built-in	
		Energy class	A+	

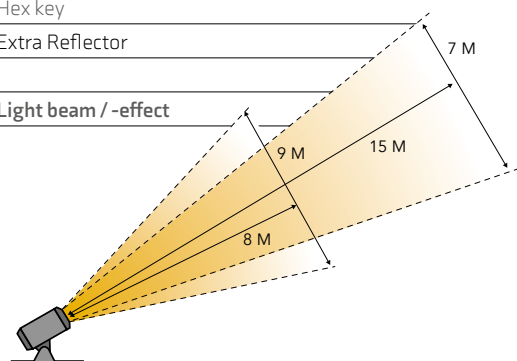

03.

Wall lights

For garden and terrace

The Lightpro wall lights illuminate a fence, garden wall, canopy and of course the front door in no time at all. The wall lights are ideal for emphasising the depth of the garden in the evenings.



Wall lights

**The possibilities of wall lights are
virtually endless.**

Create depth by attaching several wall lights to a fence. If you want to highlight a path, then place the Kuma closer to the ground, so the light becomes functional. Canopies and pergolas are brought even more to the foreground with the right wall light. We recommend the shutter wall light if you want to have full control of the light beam.

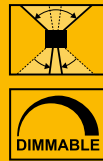

NEW

Ixion
Aluminium - Anthracite LED 9W
3.000K - 534lm

NEW

Quartz
Aluminium - Black LED 2W
3.000K - 120lm



Polaris
Aluminium - Anthracite LED 6W
3.000K - 500lm



Kuma
Aluminium - Anthracite LED 6W
3.000K - 294lm



Kuma



Polaris





Ixion

Ixion

Article number 182W | EAN code 5907800859935 | HS code 94054091 | Warranty 5 Years

Product		Light source		Supplied accessories / contents
Material	Aluminium	Type	COB	Mounting material
Colour	Anthracite	Replaceable	No	F connector
Cable	3m SPT-1W	Voltage	12 V AC/DC	Hex key
Depth	110 mm	Start-up voltage	9 V	
Width	110 mm	Wattage	9 W	
Height	110 mm	Lumen output	534 lm	
Drillhole	-	Light colour (CCT)	3.000 K	Light beam / -effect
IP class	IP44	Light angle	0 - 90°	
Protection class	III	Average lifetime	20.000 hours	
		CRI	84	
		Switch on / off	10.000	
		Dimmable	Yes, built-in	
		Energy class	A	

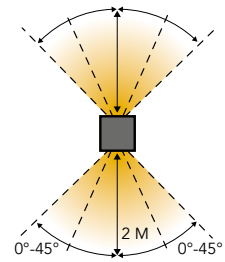

Quartz

Article number 196W | EAN code 8719979281083 | HS code 94054091 | Warranty 5 Years

Product		Light source		Supplied accessories / contents
Material	Aluminium	Type	MR11	Mounting material
Colour	Black	Replaceable	Yes	F connector
Cable	3m SPT-1W	Voltage	12 V AC/DC	Ground spike
Depth	85 mm	Start-up voltage	9 V	
Width	50 mm	Wattage	2 W	
Height	105 mm	Lumen output	120 lm	
Drillhole	-	Light colour (CCT)	3.000 K	Light beam / -effect
IP class	IP44	Light angle	30°	
Protection class	III	Average lifetime	20.000 hours	
		CRI	83	
		Switch on / off	10.000	
		Dimmable	No	
		Energy class	A+	

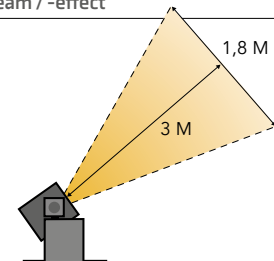

Polaris

Article number 185W | EAN code 5907800859966 | HS code 94054091 | Warranty 5 Years

Product		Light source		Supplied accessories / contents
Material	Aluminium	Type	SMD	Mounting material
Colour	Anthracite	Replaceable	No	F connector
Cable	3m SPT-1W	Voltage	12 V AC/DC	
		Start-up voltage	9 V	
Depth	35 mm	Wattage	6 W	
Diameter	145 mm	Lumen output	495 lm	
Drillhole	-	Light colour (CCT)	3.000 K	Light beam / -effect
IP class	IP44	Light angle	360°	
Protection class	III	Average lifetime	20.000 hours	
		CRI	83	
		Switch on / off	10.000	
		Dimmable	No	
		Energy class	A+	

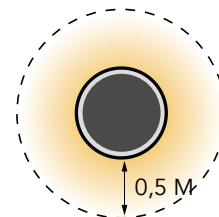

Kuma

Article number 184W | EAN code 5907800859959 | HS code 94054091 | Warranty 5 Years

Product		Light source		Supplied accessories / contents
Material	Aluminium	Type	SMD	Mounting material
Colour	Anthracite	Replaceable	No	F connector
Cable	3m SPT-1W	Voltage	12 V AC/DC	
		Start-up voltage	9 V	
Depth	35 mm	Wattage	6 W	
Diameter	145 mm	Lumen output	294 lm	
Drillhole	-	Light colour (CCT)	3.000 K	Light beam / -effect
IP class	IP44	Light angle	90°	
Protection class	III	Average lifetime	20.000 hours	
		CRI	83	
		Switch on / off	10.000	
		Dimmable	No	
		Energy class	A	

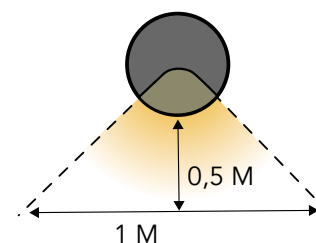

04.

Uplights

Illuminate the garden with high end uplights

Lightpro uplights can illuminate a tree, plane tree or other object from below. They can be perfectly concealed in the ground or in the gravel so that they do not stand out during the day. In the evening they give a beautiful lighting effect.



Our uplights are ground spots that can be used for various purposes. In addition to accentuating objects, uplights are also very functional.

While they are invisible during the day, in the evening they stunningly highlight the height of the trees and their leaves. The range of light and the angle of light play an important role in the choice of the spotlight. So when choosing the right uplight, make sure to thoroughly check the product specifications.



Agate LED 3W
Stainless steel 316 3.000K - 190lm



Atik R1 LED 9W
Aluminium - Anthracite 3.000K - 750lm



Atik R2 LED 9W
Stainless steel 316 3.000K - 750lm



Atik R2

Agate

Article number 102U | EAN code 5907800856774 | HS code 94054091 | Warranty 5 Years

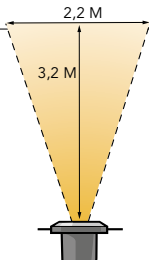
Product		Light source		Supplied accessories / contents
Material	Stainless steel 316	Type	MR16	Ground tube
Colour	Stainless steel	Replaceable	Yes	F connector
Cable	1 m. Ho5RN-F	Voltage	12 V AC/DC	Hex key
		Start-up voltage	9 V	
Diameter	113 mm	Wattage	3 W	
Height	113 mm	Lumen output	190 lm	
Drillhole	90 mm	Light colour (CCT)	3.000 K	Light beam / -effect 
IP class	IP67	Light angle	40°	
Protection class	III	Average lifetime	20.000 hours	
Overrijdbaar	Yes (car)	CRI	84	
		Switch on / off	10.000	
		Dimmable	No	
		Energy class	A+	

Atik R1

Article number 186U | EAN code 5907800859973 | HS code 94054091 | Warranty 5 Years

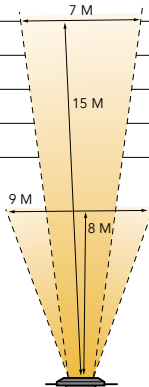
Product		Light source		Supplied accessories / contents
Material	Aluminium	Type	COB	Ground tube
Colour	Anthracite	Replaceable	No	F connector
Cable	1 m. Ho5RN-F	Voltage	12 V AC/DC	Hex key
		Start-up voltage	9 V	Extra Reflector
Diameter	120 mm	Wattage	9 W	
Height	115 mm	Lumen output	750 lm	
Drillhole	100 mm	Light colour (CCT)	3.000 K	Light beam / -effect 
IP class	IP67	Light angle	23° / 60°	
Protection class	III	Average lifetime	20.000 hours	
Overrijdbaar	No	CRI	92	
		Switch on / off	10.000	
		Dimmable	Yes, built-in	
		Energy class	A+	

Atik R2

Article number 187U | EAN code 5907800859980 | HS code 94054091 | Warranty 5 Years

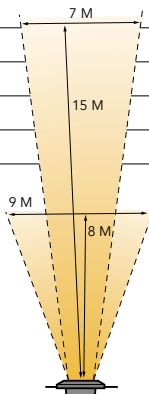
Product		Light source		Supplied accessories / contents
Material	Aluminium	Type	COB	Ground tube
Colour	Anthracite	Replaceable	No	F connector
Cable	1 m. Ho5RN-F	Voltage	12 V AC/DC	Hex key
		Start-up voltage	9 V	Extra Reflector
Diameter	120 mm	Wattage	9 W	
Height	115 mm	Lumen output	750 lm	
Drillhole	100 mm	Light colour (CCT)	3.000 K	Light beam / -effect 
IP class	IP67	Light angle	23° / 60°	
Protection class	III	Average lifetime	20.000 hours	
Overrijdbaar	No	CRI	92	
		Switch on / off	10.000	
		Dimmable	Yes, built-in	
		Energy class	A+	

05.

Decklights

Lightpro decklights create a modern ambience and are also very easy to install. Our wide range of high-quality lighting offers the best solution for every garden.



Our 12-volt decklights are ideal to use as orientation lighting.

For optimum results, we recommend installing several decklights. Imagine for example a line of lights on the side of a path, or install them randomly for a beautiful, playful effect!



Onyx 30 R1 LED 0,5W
Stainless steel 316 2.700K - 4lm



Onyx 60 R1 LED 1W
Stainless steel 316 2.700K - 23lm



Onyx 60 R3 LED 1W
Stainless steel 316 2.700K - 23lm



Onyx 60 R4 LED 1W
Stainless steel 316 2.700K - 23lm



Onyx 90 R1 LED 1,5W
Stainless steel 316 2.700K - 76lm

Onyx 30 R1

Article number 150D | EAN code 5907800857993 | HS code 94054091 | Warranty 5 Years

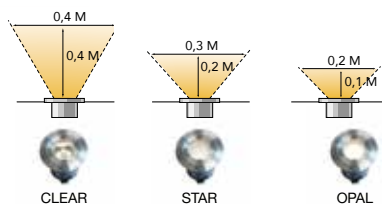
Product		Light source		Supplied accessories / contents
Material	Stainless steel 316	Type	SMD	Extra glasses
Colour	Stainless steel	Replaceable	No	F connector
Cable	1 m. H05RN-F	Voltage	12 V AC/DC	
		Start-up voltage	9 V	
Diameter	45 mm	Wattage	0,5 W	
Height	41 mm	Lumen output	4 lm	
Drillhole	30 mm	Light colour (CCT)	2,700 K	Light beam / -effect
IP class	IP67	Light angle	-	
Protection class	III	Average lifetime	20.000 hours	
Overrijdbaar	Yes (car)	CRI	83	
		Switch on / off	10.000	
		Dimmable	No	
		Energy class	-	

Onyx 60 R1

Article number 151D | EAN code 5907800858006 | HS code 94054091 | Warranty 5 Years

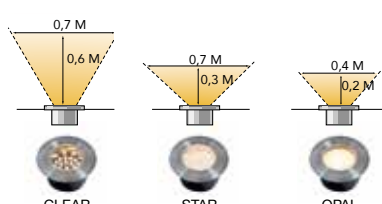
Product		Light source		Supplied accessories / contents
Material	Stainless steel 316	Type	SMD	Extra glasses
Colour	Stainless steel	Replaceable	No	F connector
Cable	1 m. H05RN-F	Voltage	12 V AC/DC	
		Start-up voltage	9 V	
Diameter	75 mm	Wattage	1 W	
Height	42 mm	Lumen output	23 lm	
Drillhole	60 mm	Light colour (CCT)	2,700 K	Light beam / -effect
IP class	IP67	Light angle	-	
Protection class	III	Average lifetime	20.000 hours	
Overrijdbaar	Yes (car)	CRI	84	
		Switch on / off	10.000	
		Dimmable	No	
		Energy class	-	

Onyx 60 R3

Article number 153D | EAN code 5907800856903 | HS code 94054091 | Warranty 5 Years

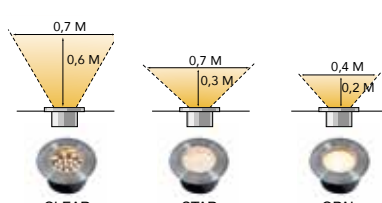
Product		Light source		Supplied accessories / contents
Material	Stainless steel 316	Type	SMD	Extra glasses
Colour	Stainless steel	Replaceable	No	F connector
Cable	1 m. H05RN-F	Voltage	12 V AC/DC	
		Start-up voltage	9 V	
Diameter	75 mm	Wattage	1 W	
Height	42 mm	Lumen output	23 lm	
Drillhole	60 mm	Light colour (CCT)	2,700 K	Light beam / -effect
IP class	IP67	Light angle	-	
Protection class	III	Average lifetime	20.000 hours	
Overrijdbaar	Yes (car)	CRI	84	
		Switch on / off	10.000	
		Dimmable	No	
		Energy class	-	

Onyx 6o R4

Article number 154D | EAN code 5907800858037 | HS code 94054091 | Warranty 5 Years

Product		Light source		Supplied accessories / contents
Material	Stainless steel 316	Type	SMD	Extra glasses
Colour	Stainless steel	Replaceable	No	F connector
Cable	1 m. H05RN-F	Voltage	12 V AC/DC	
		Start-up voltage	9 V	
Diameter	75 mm	Wattage	1 W	
Height	42 mm	Lumen output	23 lm	
Drillhole	60 mm	Light colour (CCT)	2,700 K	Light beam / -effect
IP class	IP67	Light angle	-	
Protection class	III	Average lifetime	20.000 hours	
Overrijdbaar	Yes (car)	CRI	84	
		Switch on / off	10.000	
		Dimmable	No	
		Energy class	-	

Onyx 9o R1

Article number 156D | EAN code 5907800858051 | HS code 94054091 | Warranty 5 Years

Product		Light source		Supplied accessories / contents
Material	Stainless steel 316	Type	LED warm white	Extra glasses
Colour	Stainless steel	Replaceable	No	F connector
Cable	1 m. H05RN-F	Voltage	12 V AC/DC	
		Start-up voltage	9 V	
Diameter	105 mm	Wattage	1,5 W	
Height	43 mm	Lumen output	38 lm	
Drillhole	90 mm	Light colour (CCT)	2,700 K	Light beam / -effect
IP class	IP67	Light angle	-	
Protection class	III	Average lifetime	20.000 hours	
Overrijdbaar	Yes (car)	CRI	84	
		Switch on / off	10.000	
		Dimmable	No	
		Energy class	A+	



Clear



Star



Opal

06.

LED Strip

Our multi-purpose LED strip is made of durable silicone and gives a warm light. The LED strip is perfect to use for steps, borders or in canopies. It increases safety and ambience in the garden in a simple manner.

The LED strip is 15 metres long, has a connection terminal for the connector every 50 cm and can be shortened as desired.



LED Strip

LED Strip
Synthetic

LED Strip connector
Synthetic



LED Strip

Article number 175L | EAN code 5907800859850 | HS code 94054039 | Warranty 5 Years

Product		Light source		Supplied accessories / contents
Material	Synthetic	Type	SMD	
Colour	White	Replaceable	No	
Cable	-	Voltage	12 V AC/DC	
Length	15 m	Start-up voltage	9 V	
Width	10 mm	Wattage	2,2 W / m	
Height	15 mm	Lumen output	80 lm / m	
Drillhole	-	Light colour (CCT)	3.000 K	Light beam / -effect
IP class	IP67	Light angle	-	
Protection class	III	Average lifetime	20.000 hours	
		CRI	81	
		Switch on / off	10.000	
		Dimmable	No	
		Energy class	A	

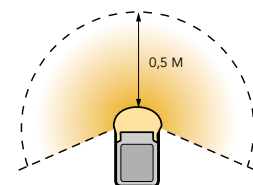

07.

Accessories

Installing 12 volt outdoor lighting? Not without accessories!

Accessories such as transformers, connectors and cables are indispensable when installing 12 volt outdoor lighting. However, also consider a motion detector, our SMART solution and a remote control, all of which can add value to the lighting plan. Discover our wide range of accessories and create the garden according entirely to your liking.





21W 158A
Transformer



60W 144A EU
Transformer 163A UK



100W 145A EU
Transformer 164A UK





Extension cable SPT-2W - 6m
for sensor 162A



12 volt Extension cable
SPT-2W - 1m 146A
SPT-2W - 3m 147A



12 volt cable 14AWG
025C14 25m



12 volt cable 14AWG
050C14 50m



12 volt cable 14AWG
100C14 100m



12 volt cable 14AWG
200C14 200m



Connector F 137A
Type F (Female)



Connector M 138A
Type M (Male)



Connector Y 143A
Type Y (for transformer)

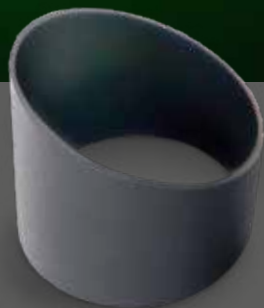

**Castor
Anti-glare hood** 189A



Connector YF 173A
Type Y (for transformer)
Not sold separately





NEW Switch 195A



Motion Sensor 165A



Remote + Receiver 166A



Receiver 167A





