

EP8390 - Elipta Micro Waymarker 90



Installation notes

Ensure mains supply is isolated prior to installation of this product.

Provide 300mm depth of shingle drainage below the up light.

Do not use in waterlogged ground.

Refer to the instruction manual for further guidance.

Note – This product must be installed by a qualified electrician.

Part code	EP8390
Diffuser	Clear
Dimensions (mm)	60x70
Cut-out dimensions (mm)	With Sleeve – 40 Without Sleeve - 36
Cable length (mm)	2000
Construction	316 Grade Stainless Steel/Aluminium
Finish	Stainless Steel
Class	Class III
IP rating	IP67
Wattage	3W
Lumen output	100lm
CCT	2700K
Lamp included	Yes, non-replaceable
Dimmable	No
Input voltage	12/24V DC
Net weight (g)	435
Gross weight (g)	475
Warranty	3 Years
Manufactured in accordance with	BS EN 60598
Origin of manufacture	PRC

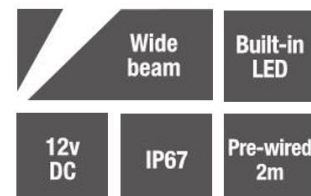

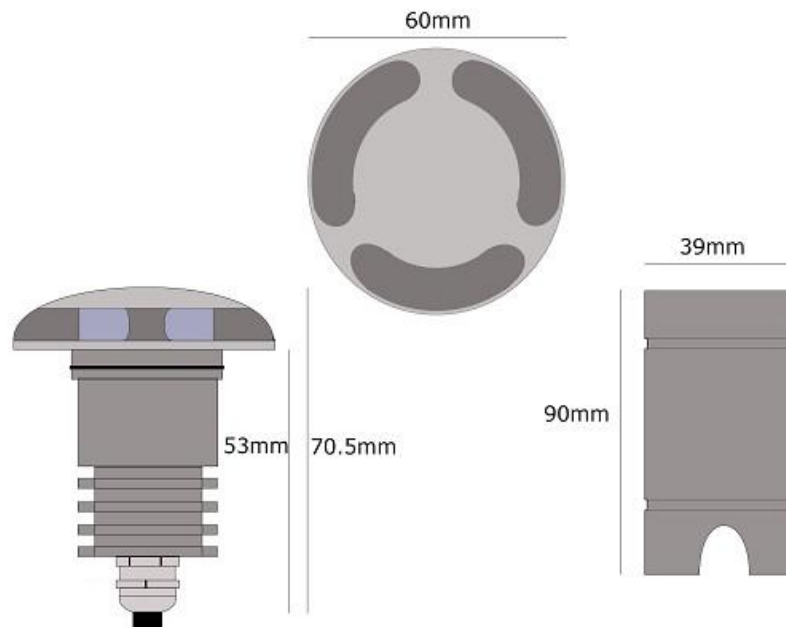

3 YEAR WARRANTY

Exclusions: Damage by machinery, animals or the use of incorrect cleaning materials.
Corrosion due to exposure to salt or chlorine.
Damage due to incorrect installation practices.
Responsibility for 3rd party cost; indirect or consequential loss